

# MEGIFLEX B

TECHNISCHE DATEN TECHNICAL DATA





SCAN →



Bitte benutzen Sie Ihr Smartphone mit der entsprechenden Software, scannen Sie den QR-Code ein.

Please use your smartphone with the relevant software, scan the QR-Code.

GET INFO →



Sie erhalten die Information, ob dies die aktuellste Version ist.

You will get the information whether you have got the latest version.



07/2018

Das Handsymbol kennzeichnet Seiten, auf denen es eine Veränderung zur Vorgängerversion gibt.  
The hand symbol appears on pages which differ from the previous catalogue version.

# INHALT CONTENTS

<b>Eigenschaften</b>	<b>04</b>	Characteristics	<b>04</b>
<b>Baureihenübersicht</b>	<b>06</b>	Summary of Series	<b>06</b>
<b>Technische Daten</b>	<b>08</b>	Technical Data	<b>08</b>
Leistungsdaten	08	Performance Data	08
Geometrische Daten	10	Geometric Data	10
Baureihe 1700	10	Series 1700	10
Baureihe 1701	12	Series 1701	12
Baureihe 1710	14	Series 1710	14
Baureihe 1711	16	Series 1711	16
Baureihe 1720	18	Series 1720	18
Baureihe 1721	20	Series 1721	20
Baureihe 1730	22	Series 1730	22
Baureihe 1731	24	Series 1731	24
Baureihe 1740	26	Series 1740	26
Baureihe 1750	28	Series 1750	28
<b>Gelenkwellausführung</b>	<b>30</b>	Cardan Shaft Design	<b>30</b>
<b>Erläuterungen des Productcodes</b>	<b>32</b>	Explanations of the Product Code	<b>32</b>
<b>Online-Service</b>	<b>34</b>	Online-Service	<b>34</b>
<b>Gültigkeitsklausel</b>	<b>35</b>	Validity Clause	<b>35</b>



# MEGIFLEX B

## EIGENSCHAFTEN CHARACTERISTICS

# DREHMOMENT TORQUE RANGE 0.010 kNm – 3.125 kNm

### EINSATZGEBIETE

**Für elastisch und starr aufgestellte dieselmotorische Haupt- und Nebenantriebe im niedrigen Leistungsbereich.**

Die MEGIFLEX B ist eine vielseitig einsetzbare, hochelastische Kupplung. Mit ihrem modularen Aufbau in Kombination mit einem druckbelasteten Element rundet die MEGIFLEX B das VULKAN Produktportfolio im Drehmomentbereich kleiner VULKARDAN E und VULASTIK L Kupplungen ab. Das Gummielement kann durch sein drehweiches, stoßdämpfendes und allseits nachgiebiges Verhalten den unterschiedlichsten Anforderungen gerecht werden.

Typische Anwendungen sind Hauptantriebe insbesondere mit kleinen Pods oder Nebenantriebe wie Getriebe PTO/ PTI mit angeschlossenen Aggregaten.

Die MEGIFLEX B ist in 15 Größen mit je 2 Gummisteifigkeiten als radial ausbaubare oder axial gesteckte Version verfügbar. Neben dem sehr kompakten Element ist die MEGIFLEX B in doppelkardanischer Ausführung als hochverlagernde und drehelastische Gelenkwelle für verschiedenste Einbausituationen anpassbar. Dank der Bauweise hat die MEGIFLEX B eine integrale Durchdrehsicherung.

### PRODUKTVORTEILE

- ⊕ Durch modularen Aufbau sowohl in radial als auch axial ausbaubarer Ausführung und als drehelastische Gelenkwelle verfügbar zur Sicherstellung höchster Lösungsflexibilität
- ⊕ Effektive Schwingungsdämpfung und hohe Verlagerungskapazität garantieren Schutz angeschlossener Aggregate und damit eine hohe Verfügbarkeit der Antriebsanlage
- ⊕ Einfache Montage dank axial gesteckter oder axial verschraubter Elemente
- ⊕ Geräuschdämpfend für höchste Komfortansprüche

### AREAS OF APPLICATION

**For flexibly and rigidly mounted diesel main propulsion and auxiliary drives in the low power range.**

The MEGIFLEX B is a versatile, highly flexible coupling. With its modular design in combination with a compression-loaded element, the MEGIFLEX B complements the VULKAN product portfolio encompassing the torque range of small VULKARDAN E and VULASTIK L couplings. Due to its torsionally soft, shock-absorbing behaviour and high radial, axial and angular displacement capabilities the rubber element can meet a highly diverse range of requirements.

Typical applications are in main propulsion; in particular with small pods, or auxiliary drives such as PTO/PTI with connected power units.

The MEGIFLEX B is available in 15 sizes, each with 2 rubber stiffness classes, which can be either radially assembled or plugged in axially depending on the series. In addition to the compact design, the double cardanic MEGIFLEX B series is versatile as a highly displacing and torsionally flexible drive shaft for a broad range of installation situations. The MEGIFLEX B is designed with an inbuilt fail-safe device.

### BENEFITS

- ⊕ Through its modular design; it can endure high radial, axial and angular displacements and as a torsionally flexible cardan shaft, the MEGIFLEX B can be used in various applications for the highest solution flexibility.
- ⊕ Effective vibration damping and a high displacement capacity guarantee the protection of connected machinery and thus a high availability of the drive system
- ⊕ Easy installation as elements either assembled axial bolted or plugged in
- ⊕ Noise dampening for highest comfort standards

# MEGIFLEX B

## BAUREIHENÜBERSICHT SUMMARY OF SERIES



**1700**  
BAUREIHE SERIES  
Seite 10 Page 10

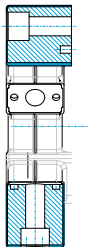

Zur Verbindung eines Flansches oder ähnlichen mit einer Nabe  
Axial verschraubte Ausführung

For connecting a flange or similar to a hub  
Axial bolted connection

Baugruppe Dimension Group J 0420 - J 2840  
Nenn Drehmoment Nominal Torque 0.01 kNm - 3.125 kNm



**1701**  
BAUREIHE SERIES  
Seite 12 Page 12

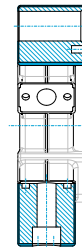

Zur Verbindung eines Flansches oder ähnlichen mit einer Nabe  
Axial steckbare Ausführung

For connecting a flange or similar to a hub  
Axial "plug-in" version

Baugruppe Dimension Group J 0420 - J 2840  
Nenn Drehmoment Nominal Torque 0.01 kNm - 3.125 kNm



**1710**  
BAUREIHE SERIES  
Seite 14 Page 14

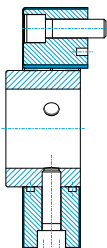

Zur Verbindung eines Flansches oder ähnlichen mit einer Welle  
Axial verschraubte Ausführung

For connecting a flange or similar to a shaft  
Axial bolted connection

Baugruppe Dimension Group J 0420 - J 2840  
Nenn Drehmoment Nominal Torque 0.01 kNm - 3.125 kNm



**1711**  
BAUREIHE SERIES  
Seite 16 Page 16

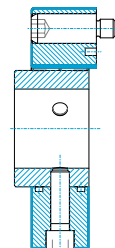

Zur Verbindung eines Flansches oder ähnlichen mit einer Welle  
Axial steckbare Ausführung

For connecting a flange or similar to a shaft  
Axial "plug-in" version

Baugruppe Dimension Group J 0420 - J 2840  
Nenn Drehmoment Nominal Torque 0.01 kNm - 3.125 kNm



**1720**  
BAUREIHE SERIES  
Seite 18 Page 18

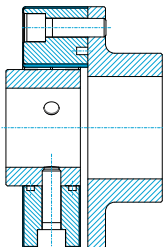

Zur Verbindung zweier Wellen  
Axial verschraubte Ausführung

For connecting two shafts  
Axial bolted connection

Baugruppe Dimension Group J 0420 - J 2840  
Nenn Drehmoment Nominal Torque 0.01 kNm - 3.125 kNm



**1721**  
BAUREIHE SERIES  
Seite 20 Page 20

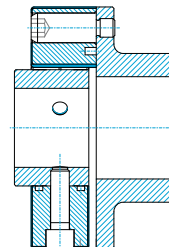

Zur Verbindung zweier Wellen  
Axial steckbare Ausführung

For connecting two shafts  
Axial "plug-in" version

Baugruppe Dimension Group J 0420 - J 2840  
Nenn Drehmoment Nominal Torque 0.01 kNm - 3.125 kNm



**1730**  
BAUREIHE SERIES  
Seite 22 Page 22

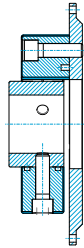

Zur Verbindung eines SAE-Schwungrades  
mit einer Welle

For connecting a SAE flywheel  
J620 to a shaft

Axial verschraubte Ausführung

Axial bolted connection

Baugruppe Dimension Group

J 1030 - J 2840

Nenn Drehmoment Nominal Torque

0.08 kNm - 3.125 kNm



**1731**  
BAUREIHE SERIES  
Seite 24 Page 24

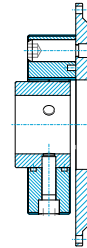

Zur Verbindung eines SAE-Schwungrades  
mit einer Welle

For connecting a SAE flywheel  
J620 to a shaft

Axial steckbare Ausführung

Axial "plug-in" version

Baugruppe Dimension Group

J 1030 - J 2840

Nenn Drehmoment Nominal Torque

0.08 kNm - 3.125 kNm



**1740**  
BAUREIHE SERIES  
Seite 26 Page 26

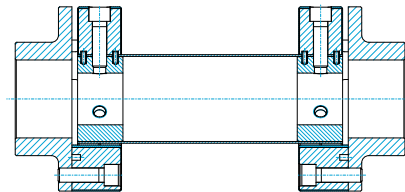

Drehelastische Gelenkwellenausführung

Elementwechsel ohne Verschieben der verbundenen Maschinen

Torsionally flexible cardan shaft design

Replacement of elements without moving the adjacent machinery

Baugruppe Dimension Group

J 0420 - J 2840

Nenn Drehmoment Nominal Torque

0.01 kNm - 3.125 kNm



**1750**  
BAUREIHE SERIES  
Seite 28 Page 28

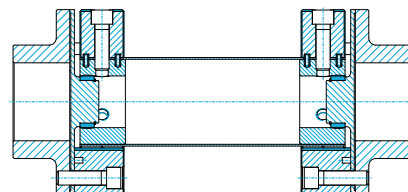

Drehelastische Gelenkwellenausführung

Elementwechsel ohne Verschieben der verbundenen Maschinen mit innerer Abstützung

Torsionally flexible cardan shaft design

Replacement of elements without moving the adjacent machinery, with inner support

Baugruppe Dimension Group

J 0420 - J 2840

Nenn Drehmoment Nominal Torque

0.01 kNm - 3.125 kNm

# MEGIFLEX B

## LEISTUNGSDATEN PERFORMANCE DATA

Kupplungstyp Type of Coupling		$T_{KN}$	$T_{Kmax1}$	$T_{KW}$	$P_{KV50}$	$n_{Kmax}$	$\Delta K_r^{3)}$	$C_{rdyn}$	$\Delta K_a$	$C_{ax}$	$\Delta K_w^{3)}$	$C_{wdyn}$	$C_{tdyn}^{1)2)}$	$\psi^{1)2)}$
		[Nm]	[Nm]	[Nm]	[W]	[1/min]	[mm]	[N/mm]	[mm]	[N/mm]	[°]	[Nm/°]	[Nm/rad] nominal	nominal
Größe Size	Baugruppe Dimension Group	Nennrehmoment Nominal Torque	Max. Drehmoment <sub>1</sub> Max. Torque <sub>1</sub>	Wechsel-drehmoment Vibratory Torque	Verlustleistung Power Loss	Drehzahl Rotational Speed	Radialer Kupplungsversatz Radial Coupling Displacement	Radiale Federsteife Radial Stiffness	Axialer Kupplungsversatz Axial Coupling Displacement	Axiale Federsteife Axial Stiffness	Winkliger Kupplungsversatz Angular Coupling Displacement	Winklige Federsteife Angular Stiffness	Dynamische Drehfedersteife Dynamic Torsional Stiffness	Verhältnismäßige Dämpfung Relative Damping
0421	0420	10,0	20,0	5,0	16,7	10000	1,5	130,0	2,0	25,0	3,0	0,27	80	0,75
0422	0420	12,5	30,0	6,2	16,7	10000	1,0	195,0	1,3	38,0	2,1	0,40	110	0,75
0621	0620	20,0	40,0	10,0	23,3	8000	1,5	130,0	3,0	15,0	3,0	0,27	160	0,75
0622	0620	25,0	60,0	12,5	23,3	8000	1,0	195,0	2,0	22,0	2,1	0,40	220	0,75
0831	0830	40,0	80,0	20,0	30,0	7000	1,5	435,0	3,0	50,0	3,0	2,10	460	0,75
0832	0830	50,0	120,0	25,0	30,0	7000	1,0	650,0	2,0	75,0	2,1	3,10	650	0,75
1031	1030	80,0	160,0	40,0	40,0	6500	2,0	435,0	4,0	50,0	3,0	3,10	820	0,75
1032	1030	100,0	240,0	50,0	40,0	6500	1,3	650,0	2,7	75,0	2,1	4,20	1150	0,75
1041	1040	120,0	240,0	60,0	50,0	6500	2,0	870,0	4,0	170,0	2,0	8,20	2550	0,75
1042	1040	150,0	360,0	75,0	50,0	6500	1,3	1300,0	2,7	250,0	1,4	11,70	3550	0,75
1231	1230	160,0	320,0	80,0	46,7	6000	2,0	435,0	5,0	67,0	3,0	4,30	1850	0,75
1232	1230	200,0	480,0	100,0	46,7	6000	1,3	650,0	3,3	100,0	2,1	6,50	2600	0,75
1241	1240	220,0	440,0	110,0	60,0	6000	2,0	1135,0	5,0	340,0	2,0	10,90	5850	0,75
1242	1240	275,0	660,0	138,0	60,0	6000	1,3	1700,0	3,3	500,0	1,4	15,60	8000	0,75
1431	1430	250,0	500,0	125,0	53,3	5000	2,0	520,0	5,0	95,0	3,0	6,10	2650	0,75
1432	1430	312,5	750,0	156,0	53,3	5000	1,3	780,0	3,3	140,0	2,1	9,10	3700	0,75
1441	1440	340,0	680,0	170,0	63,3	5000	2,0	1220,0	5,0	370,0	2,0	15,50	6850	0,75
1442	1440	425,0	1020,0	212,0	63,3	5000	1,3	1820,0	3,3	550,0	1,4	22,10	9500	0,75
1631	1630	400,0	800,0	200,0	60,0	4000	2,0	650,0	5,0	130,0	3,0	8,20	4100	0,75
1632	1630	500,0	1200,0	250,0	60,0	4000	1,3	975,0	3,3	190,0	2,1	11,70	5750	0,75
1641	1640	600,0	1200,0	300,0	73,3	4500	2,0	1900,0	5,0	430,0	2,0	22,50	10900	0,75
1642	1640	750,0	1800,0	375,0	73,3	4500	1,3	2850,0	3,3	650,0	1,4	33,80	15300	0,75



## LEISTUNGSDATEN PERFORMANCE DATA

Kupplungstyp Type of Coupling		$T_{KN}$	$T_{Kmax1}$	$T_{KW}$	$P_{KV50}$	$n_{Kmax}$	$\Delta K_r^{(3)}$	$C_{dyn}$	$\Delta K_a$	$C_{ax}$	$\Delta K_w^{(3)}$	$C_{wdyn}$	$C_{Tdyn}^{(1,2)}$	$\psi^{(1,2)}$
		[Nm]	[Nm]	[Nm]	[W]	[1/min]	[mm]	[N/mm]	[mm]	[N/mm]	[°]	[Nm/°]	[Nm/rad] nominal	nominal
Größe	Baugruppe	Nenn Drehmoment	Max. Drehmoment <sub>1</sub>	Wechsel-drehmoment	Verlustleistung	Drehzahl	Radialer Kupplungsversatz	Radiale Federsteife	Axialer Kupplungsversatz	Axiale Federsteife	Winkliger Kupplungsversatz	Winklige Federsteife	Dynamische Drehfedersteife	Verhältnismäßige Dämpfung
Size	Dimension Group	Nominal Torque	Max. Torque <sub>1</sub>	Vibratory Torque	Power Loss	Rotational Speed	Radial Coupling Displacement	Radial Stiffness	Axial Coupling Displacement	Axial Stiffness	Angular Coupling Displacement	Angular Stiffness	Dynamic Torsional Stiffness	Relative Damping
1741	1740	800,0	1600,0	400,0	66,7	4500	1,5	2500,0	3,0	570,0	2,0	30,90	13700	0,75
1742	1740	1000,0	2400,0	500,0	66,7	4500	1,0	3750,0	2,0	850,0	1,4	44,20	19500	0,75
2131	2130	900,0	1800,0	450,0	80,0	3600	2,0	850,0	5,0	150,0	3,0	14,70	10500	0,75
2132	2130	1125,0	2700,0	563,0	80,0	3600	1,3	1300,0	3,3	220,0	2,1	22,10	14700	0,75
2141	2140	1400,0	2800,0	700,0	90,0	3600	2,0	2000,0	5,0	430,0	2,0	34,60	24400	0,75
2142	2140	1750,0	4200,0	875,0	90,0	3600	1,3	3000,0	3,3	650,0	1,4	49,40	34500	0,75
2841	2840	2500,0	5000,0	1250,0	113,3	3000	2,0	3560,0	5,0	800,0	2,0	61,90	48750	0,75
2842	2840	3125,0	7500,0	1563,0	113,3	3000	1,3	5350,0	3,3	1150,0	1,4	88,40	78500	0,75

### Siehe Erläuterung der Technischen Daten

- VULKAN empfiehlt die zusätzliche Berücksichtigung von  $C_{Tdyn\ warm}$  (0,7),  $C_{Tdyn\ la}$  (1,35) und  $\psi_{warm}$  (0,7) für die Berechnung der Drehschwingungen in der Anlage.
- Der Betriebszustand der Anlage kann eine Korrektur der gegebenen Werte notwendig machen.  
Durch die Eigenschaft des Werkstoffs Gummi sind Toleranzen der aufgeführten Daten für  $C_{Tdyn}$  und  $\psi$  von  $\pm 35\%$  möglich.
- Die zulässige Winkel- und Radialverlagerung ist abhängig von der Drehzahl.  
Im Drehzahlbereich bis  $n = 1.500\ min^{-1}$  gelten bei Ausnutzung der Nennleistung die angegebenen Verlagerungswerte. Bei Drehzahlen über  $1.500\ min^{-1}$  reduziert sich die Verlagerungsfähigkeit um  $30\%$  je  $1.000\ min^{-1}$  Drehzahlsteigerung.

### See Explanation of the Technical Data

- VULKAN recommends additionally taking into account  $C_{Tdyn\ warm}$  (0,7),  $C_{Tdyn\ la}$  (1,35) and  $\psi_{warm}$  (0,7) for calculating the torsional vibration in the system.
- The operating state of the system can make it necessary to correct the values given.  
Due to the properties of natural rubber tolerances in the technical data of  $\pm 35\%$  for  $C_{Tdyn}$  and  $\psi$  are possible.
- The permissible angular and radial displacement is depending the rotational speed.  
The permissible displacements as mentioned are valid for a speed range up to  $n = 1.500\ min^{-1}$ . For higher speeds the permissible displacements have to be reduced by  $30\%$  per  $1.000\ min^{-1}$  above  $1.500\ min^{-1}$ .



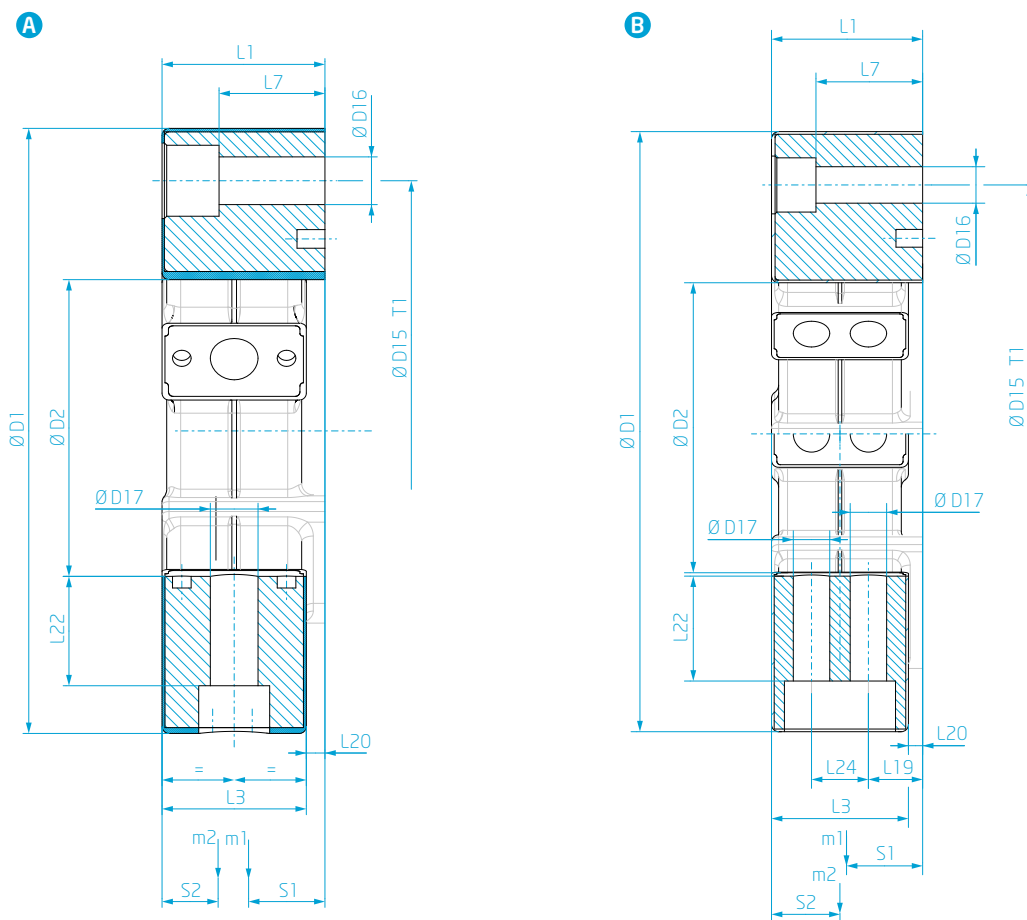

### GEOMETRISCHE DATEN GEOMETRIC DATA

Baugruppe Dimension Group	Abbildung Figure	Abmessungen Dimension								
		D <sub>1</sub> [mm]	D <sub>2</sub> [mm]	D <sub>15</sub> [mm]	T <sub>1</sub> [-] Teilung/holes	D <sub>16</sub> [mm]	D <sub>17</sub> [mm]	L <sub>1</sub> [mm]	L <sub>3</sub> [mm]	L <sub>7</sub> [mm]
J0420	A	56,0	30,0	44,0	2	6,5	6,5	24,0	22,0	18,0
J0620	A	85,0	40,0	67,0	2	8,5	8,5	24,0	20,0	12,0
J0830	A	100,0	45,0	80,0	3	8,5	8,5	28,0	24,0	17,0
J1030	A	122,0	60,0	100,0	3	10,5	10,5	32,0	28,0	20,5
J1040	A	122,0	60,0	100,0	4	10,5	10,5	32,0	28,0	20,5
J1230	A	150,0	70,0	125,0	3	12,5	12,5	42,0	36,0	23,5
J1240	A	150,0	70,0	125,0	4	12,5	12,5	42,0	36,0	23,5
J1430	A	170,0	85,0	140,0	3	14,5	14,5	46,0	40,0	26,0
J1440	A	170,0	85,0	140,0	4	14,5	14,5	46,0	40,0	26,0
J1630	A	200,0	100,0	165,0	3	16,5	16,5	58,0	50,0	34,5
J1640	A	200,0	100,0	165,0	4	16,5	16,5	58,0	50,0	34,5
J1740	A	205,0	100,0	165,0	4	16,5	16,5	65,0	61,0	34,5
J2130	A	260,0	125,0	215,0	3	20,5	20,5	70,0	62,0	45,5
J2140	A	260,0	125,0	215,0	4	20,5	20,5	70,0	62,0	45,5
J2840	B	340,0	160,0	280,0	4	20,5	20,5	85,0	77,0	60,0

Abmessungen Dimension				Massenträgheitsmomente Mass moments of inertia		Masse Mass		Schwerpunktsabstand Distance to center of gravity		Anmerkungen Notes
$L_{19}$	$L_{20}$	$L_{22}$	$L_{24}$	$J_1$	$J_2$	$m_1$	$m_2$	$S_1$	$S_2$	
[mm]	[mm]	[mm]	[mm]	[kgm <sup>2</sup> 10 <sup>-3</sup> ]	[kgm <sup>2</sup> 10 <sup>-3</sup> ]	[kg]	[kg]	[mm]	[mm]	
-	2,0	5,0	-	0,008	0,018	0,016	0,037	11,3	11,0	
-	4,0	14,2	-	0,096	0,220	0,090	0,210	11,0	10,0	
-	4,0	18,5	-	0,120	0,130	0,080	0,100	13,9	12,0	
-	4,0	20,5	-	0,350	0,340	0,150	0,150	16,0	14,0	
-	4,0	20,5	-	0,390	0,370	0,160	0,180	15,5	14,0	
-	6,0	25,2	-	0,980	1,080	0,280	0,330	21,4	18,0	
-	6,0	25,2	-	1,100	1,260	0,310	0,390	20,8	18,0	
-	6,0	27,0	-	1,850	1,780	0,400	0,410	23,1	20,0	
-	6,0	27,0	-	2,070	2,100	0,450	0,500	22,5	20,0	
-	8,0	34,5	-	4,536	4,240	0,710	0,720	29,4	25,0	
-	8,0	34,5	-	5,070	4,850	0,790	0,820	28,8	25,0	
-	4,0	34,5	-	6,650	6,950	0,990	1,130	31,5	30,5	
-	8,0	47,0	-	16,900	16,090	1,620	1,650	35,6	31,0	
-	8,0	47,0	-	18,830	19,200	1,730	1,950	34,9	30,9	
30,5	8,0	59,0	32,0	63,240	125,400	3,500	7,750	42,9	38,8	



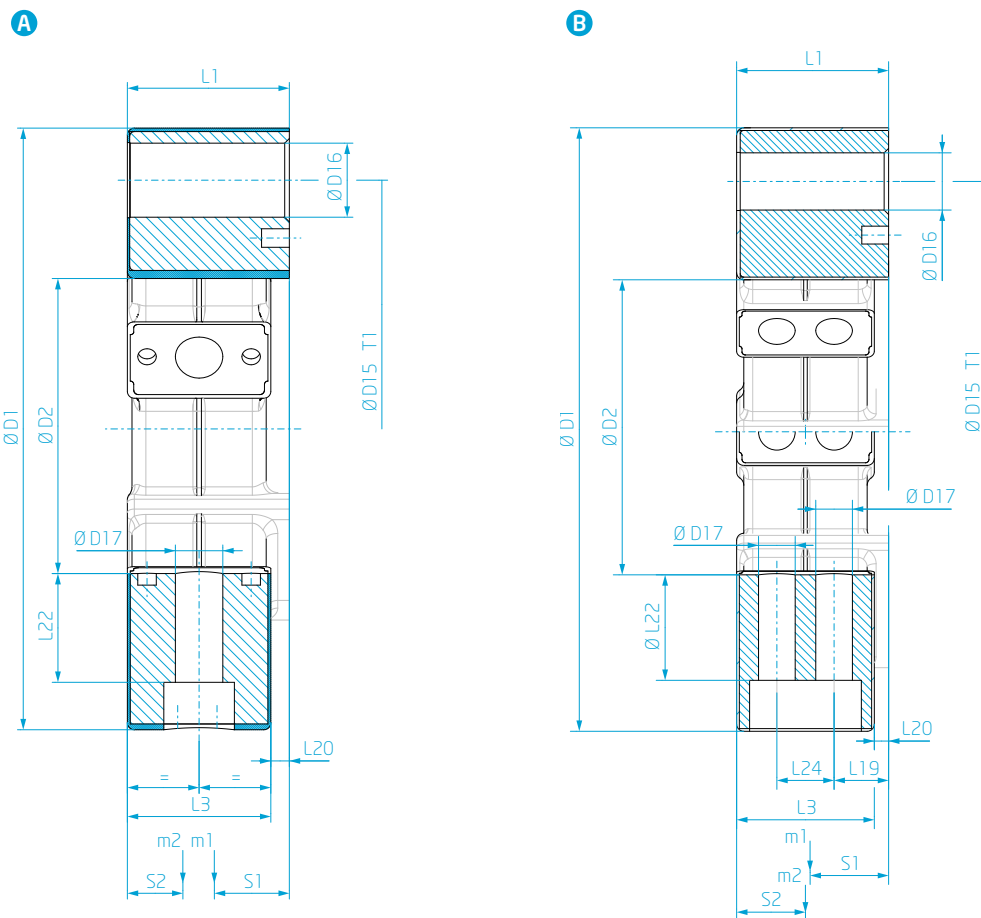

### GEOMETRISCHE DATEN GEOMETRIC DATA

Baugruppe Dimension Group	Abbildung Figure	Abmessungen Dimension								
		D <sub>1</sub> [mm]	D <sub>2</sub> [mm]	D <sub>15</sub> [mm]	T <sub>1</sub> [-] Teilung/holes	D <sub>16</sub> [mm]	D <sub>17</sub> [mm]	L <sub>1</sub> [mm]	L <sub>3</sub> [mm]	
J 0420	A	56,0	30,0	44,0	2	10,0	6,5	24,0	22,0	
J 0620	A	85,0	40,0	68,0	2	14,0	8,5	24,0	20,0	
J 0830	A	100,0	45,0	80,0	3	14,0	8,5	28,0	24,0	
J 1030	A	122,0	60,0	100,0	3	17,0	10,5	32,0	28,0	
J 1040	A	122,0	60,0	100,0	4	17,0	10,5	32,0	28,0	
J 1230	A	150,0	70,0	125,0	3	19,0	12,5	42,0	36,0	
J 1240	A	150,0	70,0	125,0	4	19,0	12,5	42,0	36,0	
J 1430	A	170,0	85,0	140,0	3	22,0	14,5	46,0	40,0	
J 1440	A	170,0	85,0	140,0	4	22,0	14,5	46,0	40,0	
J 1630	A	200,0	100,0	165,0	3	25,0	16,5	58,0	50,0	
J 1640	A	200,0	100,0	165,0	4	25,0	16,5	58,0	50,0	
J 1740	A	205,0	100,0	165,0	4	25,0	16,5	65,0	61,0	
J 2130	A	260,0	125,0	215,0	3	32,0	20,5	70,0	62,0	
J 2140	A	260,0	125,0	215,0	4	32,0	20,5	70,0	62,0	
J 2840	B	340,0	160,0	280,0	4	32,0	20,5	85,0	77,0	

Abmessungen Dimension				Massenträgheitsmomente Mass moments of inertia		Masse Mass		Schwerpunktsabstand Distance to center of gravity		Anmerkungen Notes
L <sub>19</sub>	L <sub>20</sub>	L <sub>22</sub>	L <sub>24</sub>	J <sub>1</sub>	J <sub>2</sub>	m <sub>1</sub>	m <sub>2</sub>	S <sub>1</sub>	S <sub>2</sub>	
[mm]	[mm]	[mm]	[mm]	[kgm <sup>2</sup> 10 <sup>-3</sup> ]	[kgm <sup>2</sup> 10 <sup>-3</sup> ]	[kg]	[kg]	[mm]	[mm]	
-	20	5,0	-	0,006	0,018	0,01	0,04	12,2	11,0	
-	4,0	14,2	-	0,073	0,215	0,07	0,21	12,2	10,0	
-	4,0	18,5	-	0,100	0,130	0,07	0,10	14,9	12,0	
-	4,0	20,5	-	0,290	0,340	0,12	0,15	17,0	14,0	
-	4,0	20,5	-	0,300	0,370	0,13	0,18	16,7	14,0	
-	6,0	25,2	-	0,850	1,080	0,25	0,33	22,5	18,0	
-	6,0	25,2	-	0,930	1,260	0,27	0,39	22,0	18,0	
-	6,0	27,0	-	1,600	1,800	0,35	0,42	24,3	20,0	
-	6,0	27,0	-	1,750	2,100	0,38	0,50	23,9	20,0	
-	8,0	34,5	-	3,980	4,240	0,63	0,72	30,8	25,0	
-	8,0	34,5	-	4,330	4,850	0,68	0,82	30,4	25,0	
-	4,0	34,5	-	5,900	6,940	0,88	1,13	33,1	30,5	
-	8,0	47,0	-	14,700	16,090	1,43	1,66	37,0	31,0	
-	8,0	47,0	-	15,890	19,200	1,48	1,95	36,6	30,9	
30,5	8,0	59,0	32,0	56,860	125,400	3,17	7,75	44,0	38,8	



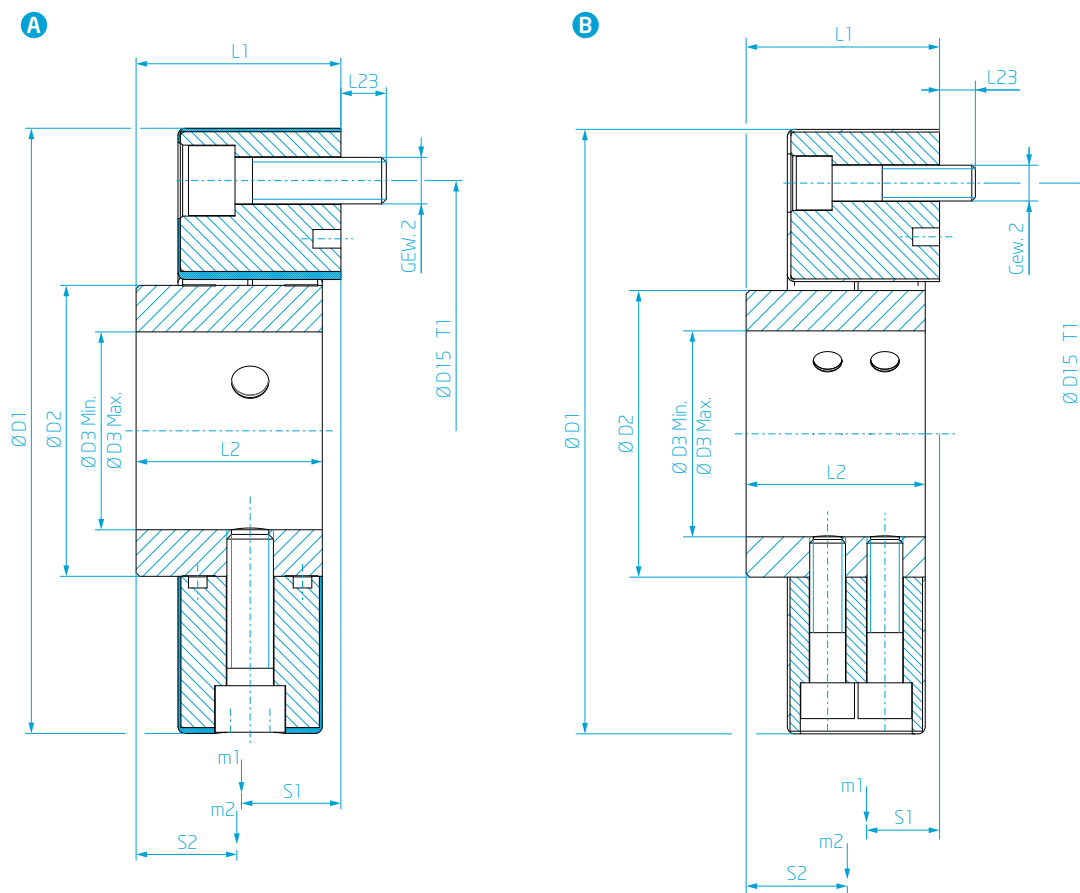

### GEOMETRISCHE DATEN GEOMETRIC DATA

Baugruppe Dimension Group	Abbildung Figure	Abmessungen Dimension						
		D <sub>1</sub> [mm]	D <sub>2</sub> [mm]	D <sub>3</sub> [mm] Min.	D <sub>3</sub> [mm] Max.	D <sub>15</sub> [mm]	T <sub>1</sub> [-] Teilung/holes	GEW.2 [mm]
J0420	A	56,0	30,0	8,0	19,0	44,0	2	M6
J0620	A	85,0	40,0	10,0	26,0	68,0	2	M8
J0830	A	100,0	45,0	12,0	30,0	80,0	3	M8
J1030	A	122,0	60,0	12,0	38,0	100,0	3	M10
J1040	A	122,0	60,0	12,0	38,0	100,0	4	M10
J1230	A	150,0	70,0	15,0	48,0	125,0	3	M12
J1240	A	150,0	70,0	15,0	48,0	125,0	4	M12
J1430	A	170,0	85,0	15,0	55,0	140,0	3	M14
J1440	A	170,0	85,0	15,0	55,0	140,0	4	M14
J1630	A	200,0	100,0	20,0	65,0	165,0	3	M16
J1640	A	200,0	100,0	20,0	65,0	165,0	4	M16
J1740	A	205,0	100,0	20,0	65,0	165,0	4	M16
J2130	A	260,0	125,0	30,0	85,0	215,0	3	M20
J2140	A	260,0	125,0	30,0	85,0	215,0	4	M20
J2840	B	340,0	160,0	40,0	115,0	280,0	4	M20

Abmessungen Dimension			Massenträgheitsmomente Mass moments of inertia		Masse Mass		Schwerpunktsabstand Distance to center of gravity		Anmerkungen Notes
$L_1$	$L_2$	$L_{23}$	$J_1$	$J_2$	$m_1$	$m_2$	$S_1$	$S_2$	
[mm]	[mm]	[mm]	[kgm <sup>2</sup> 10 <sup>-3</sup> ]	[kgm <sup>2</sup> 10 <sup>-3</sup> ]	[kg]	[kg]	[mm]	[mm]	
26,0	24,0	7,0	0,017	0,037	0,03	0,18	11,2	12,3	
32,0	28,0	8,0	0,131	0,300	0,12	0,51	10,4	15,8	
34,0	30,0	8,0	0,210	0,290	0,13	0,51	12,9	15,8	
46,0	42,0	9,5	0,590	0,940	0,24	1,16	15,1	22,4	
46,0	42,0	9,5	0,700	1,040	0,29	1,21	14,7	22,6	
56,0	50,0	11,5	1,570	2,410	0,43	1,97	19,1	26,6	
56,0	50,0	11,5	1,890	2,740	0,51	2,07	18,5	26,9	
61,0	55,0	14,0	3,010	4,840	0,63	3,05	20,6	29,0	
61,0	55,0	14,0	3,620	5,450	0,76	3,19	19,9	29,3	
74,0	66,0	15,5	7,070	11,240	1,08	5,08	26,6	34,6	
74,0	66,0	15,5	8,440	12,480	1,28	5,28	25,9	34,9	
70,0	66,0	15,5	10,030	14,580	1,48	5,59	28,1	33,7	
88,0	80,0	19,5	25,550	37,570	2,36	9,95	33,2	42,0	
88,0	80,0	19,5	30,370	42,830	2,72	10,46	32,4	42,4	
108,0	100,0	20,0	85,660	206,060	4,64	25,41	41,1	54,3	

Alle Massen, Schwerpunkte und Massenträgheitsmomente beziehen sich auf min. Nabendurchmesser.

All masses, focal points and mass moments of inertia refer to min. hub diameter.



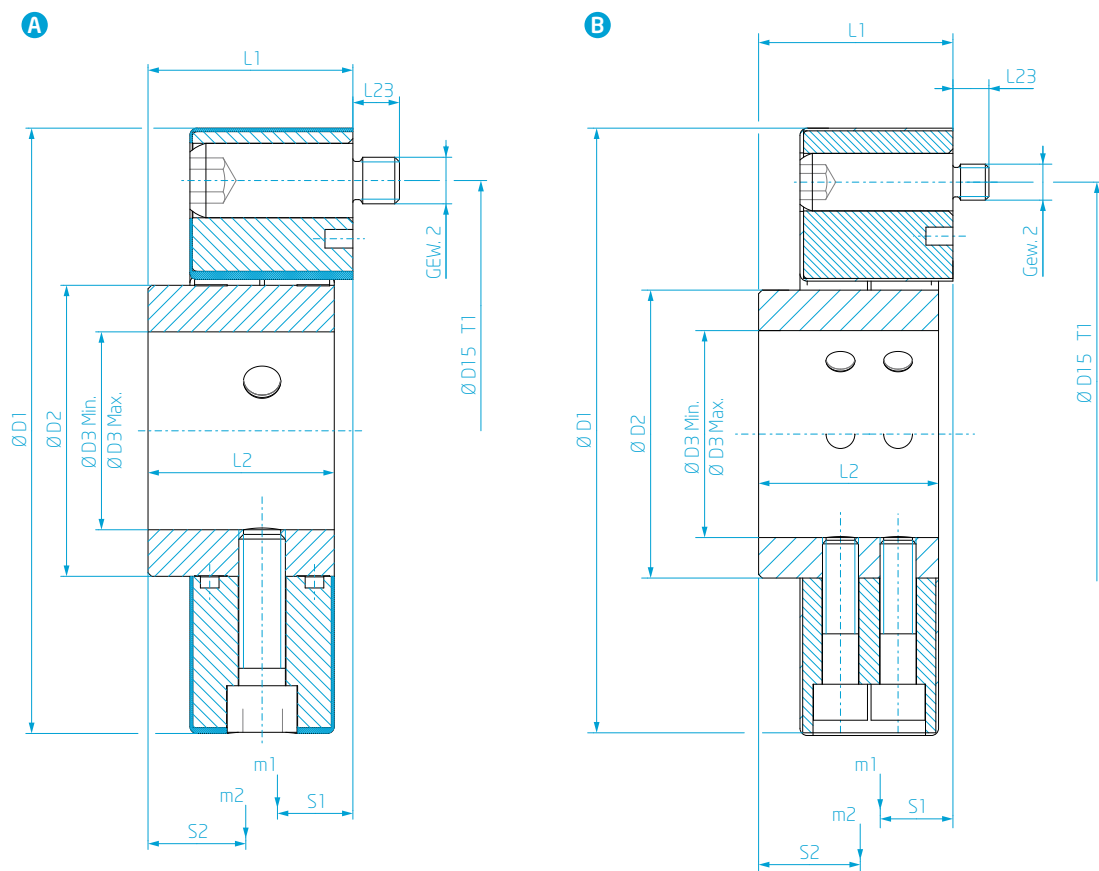

### GEOMETRISCHE DATEN GEOMETRIC DATA

Baugruppe Dimension Group	Abbildung Figure	Abmessungen Dimension						
		D <sub>1</sub> [mm]	D <sub>2</sub> [mm]	D <sub>3</sub> [mm] Min.	D <sub>3</sub> [mm] Max.	D <sub>15</sub> [mm]	T <sub>1</sub> [-] Teilung/holes	GEW.2 [mm]
J0420	A	56,0	30,0	8,0	19,0	44,0	2	M6
J0620	A	85,0	40,0	10,0	26,0	68,0	2	M8
J0830	A	100,0	45,0	12,0	30,0	80,0	3	M8
J1030	A	122,0	60,0	12,0	38,0	100,0	3	M10
J1040	A	122,0	60,0	12,0	38,0	100,0	4	M10
J1230	A	150,0	70,0	15,0	48,0	125,0	3	M12
J1240	A	150,0	70,0	15,0	48,0	125,0	4	M12
J1430	A	170,0	85,0	15,0	55,0	140,0	3	M14
J1440	A	170,0	85,0	15,0	55,0	140,0	4	M14
J1630	A	200,0	100,0	20,0	65,0	165,0	3	M16
J1640	A	200,0	100,0	20,0	65,0	165,0	4	M16
J1740	A	205,0	100,0	20,0	65,0	165,0	4	M16
J2130	A	260,0	125,0	30,0	85,0	215,0	3	M20
J2140	A	260,0	125,0	30,0	85,0	215,0	4	M20
J2840	B	340,0	160,0	40,0	115,0	280,0	4	M20



Abmessungen Dimension			Massenträgheitsmomente Mass moments of inertia		Masse Mass		Schwerpunktsabstand Distance to center of gravity		Anmerkungen Notes
$L_1$	$L_2$	$L_{23}$	$J_1$	$J_2$	$m_1$	$m_2$	$S_1$	$S_2$	
[mm]	[mm]	[mm]	[kgm <sup>2</sup> 10 <sup>-3</sup> ]	[kgm <sup>2</sup> 10 <sup>-3</sup> ]	[kg]	[kg]	[mm]	[mm]	
26,0	24,0	7,0	0,021	0,037	0,04	0,18	10,5	12,3	
32,0	28,0	8,0	0,140	0,300	0,13	0,51	10,9	15,8	
34,0	30,0	8,0	0,260	0,290	0,17	0,51	12,8	15,8	
46,0	42,0	10,0	0,720	0,940	0,30	1,16	14,5	22,4	
46,0	42,0	10,0	0,890	1,040	0,36	1,21	14,2	22,6	
56,0	50,0	12,0	1,960	2,410	0,53	1,97	19,4	26,6	
56,0	50,0	12,0	2,420	2,740	0,64	2,07	18,9	26,9	
61,0	55,0	14,0	3,640	4,850	0,76	3,05	20,8	29,0	
61,0	55,0	14,0	4,480	5,450	0,93	3,19	20,3	29,3	
74,0	66,0	16,0	8,600	11,240	1,31	5,08	26,7	34,6	
74,0	66,0	16,0	10,490	12,480	1,57	5,28	26,1	34,9	
70,0	66,0	16,0	12,070	14,580	1,78	5,59	27,9	33,7	
88,0	80,0	20,0	30,360	37,570	2,77	9,95	32,6	42,0	
88,0	80,0	20,0	36,770	42,830	3,27	10,46	31,9	42,4	
108,0	100,0	20,0	99,570	206,060	5,34	25,41	40,6	54,3	

Alle Massen, Schwerpunkte und Massenträgheitsmomente beziehen sich auf min. Nabendurchmesser.

All masses, focal points and mass moments of inertia refer to min. hub diameter.



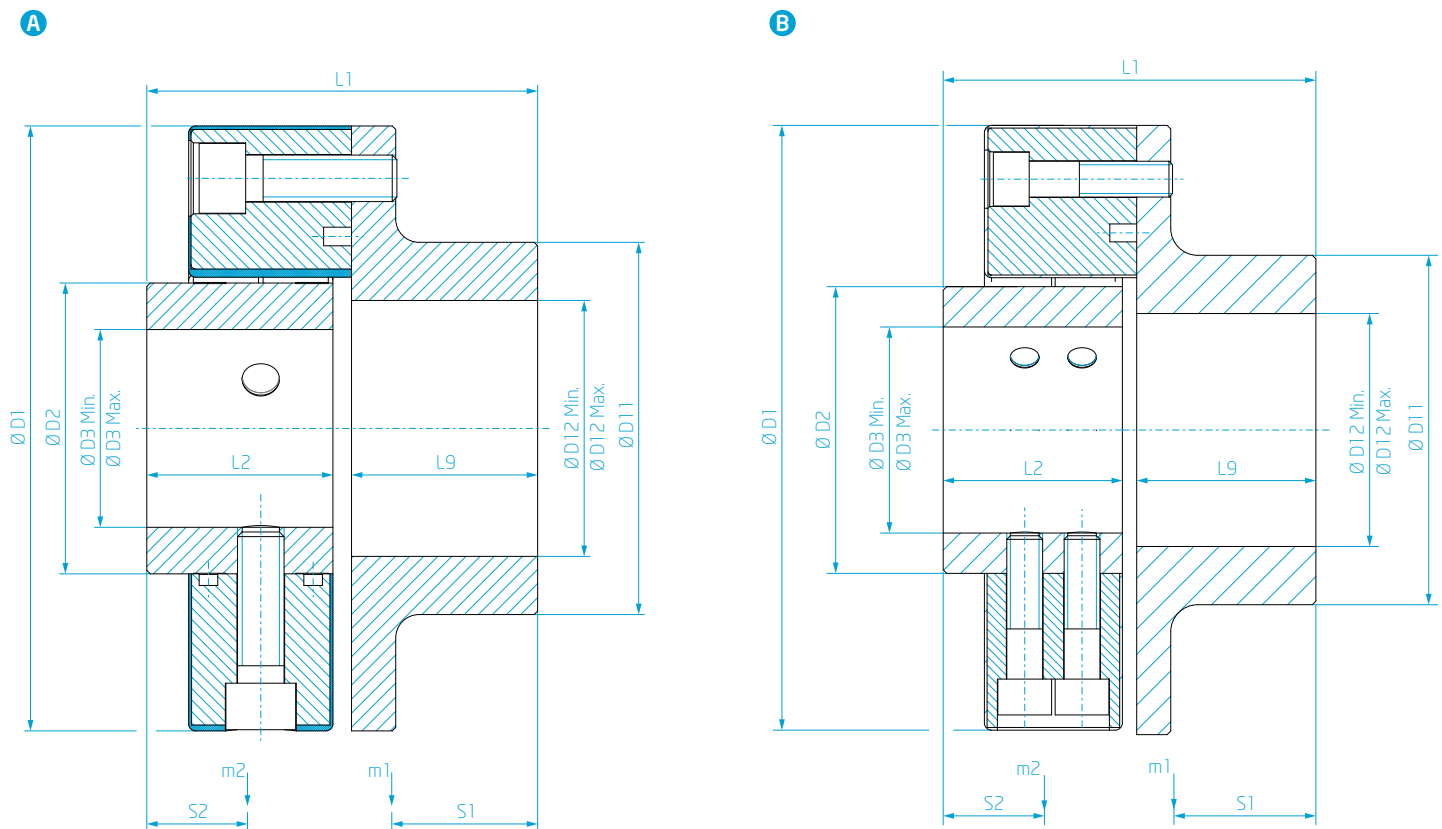

### GEOMETRISCHE DATEN GEOMETRIC DATA

Baugruppe Dimension Group	Abbildung Figure	Abmessungen Dimension							
		D <sub>1</sub> [mm]	D <sub>2</sub> [mm]	D <sub>3</sub> [mm]		D <sub>11</sub> [mm]	D <sub>12</sub> [mm]		
				Min.	Max.		Min.	Max.	
J 0420	A	56,0	30,0	8,0	19,0	36,0	8,0	25,0	
J 0620	A	85,0	40,0	10,0	26,0	55,0	12,0	38,0	
J 0830	A	100,0	45,0	12,0	30,0	65,0	15,0	45,0	
J 1030	A	122,0	60,0	12,0	38,0	80,0	18,0	55,0	
J 1040	A	122,0	60,0	12,0	38,0	80,0	18,0	55,0	
J 1230	A	150,0	70,0	15,0	48,0	100,0	20,0	70,0	
J 1240	A	150,0	70,0	15,0	48,0	100,0	20,0	70,0	
J 1430	A	170,0	85,0	15,0	55,0	115,0	20,0	85,0	
J 1440	A	170,0	85,0	15,0	55,0	115,0	20,0	85,0	
J 1630	A	200,0	100,0	20,0	65,0	140,0	25,0	100,0	
J 1640	A	200,0	100,0	20,0	65,0	140,0	25,0	100,0	
J 1740	A	205,0	100,0	20,0	65,0	140,0	25,0	100,0	
J 2130	A	260,0	125,0	30,0	85,0	160,0	30,0	110,0	
J 2140	A	260,0	125,0	30,0	85,0	160,0	30,0	110,0	
J 2840	B	340,0	160,0	40,0	115,0	195,0	40,0	130,0	

Abmessungen Dimension			Massenträgheitsmomente Mass moments of inertia		Masse Mass		Schwerpunktsabstand Distance to center of gravity		Anmerkungen Notes
$L_1$	$L_2$	$L_9$	$J_1$	$J_2$	$m_1$	$m_2$	$S_1$	$S_2$	
[mm]	[mm]	[mm]	[kgm <sup>2</sup> 10 <sup>-3</sup> ]	[kgm <sup>2</sup> 10 <sup>-3</sup> ]	[kg]	[kg]	[mm]	[mm]	
50,0	24,0	24,0	0,09	0,04	0,30	0,18	16,7	12,3	
60,0	28,0	28,0	0,59	0,30	0,84	0,51	19,9	15,8	Alle Massen, Schwerpunkte und Massenträgheitsmomente beziehen sich auf min. Nabendurchmesser.
64,0	30,0	30,0	1,11	0,29	1,19	0,51	20,7	15,8	
88,0	42,0	42,0	3,17	0,94	2,39	1,16	27,9	22,4	
88,0	42,0	42,0	3,28	1,04	2,43	1,21	28,4	22,6	
106,0	50,0	50,0	9,13	2,41	4,43	1,97	33,2	26,6	
106,0	50,0	50,0	9,41	2,74	4,50	2,07	33,7	26,9	Alle Massen, Schwerpunkte und mass moments of inertia refer to min. hub diameter.
116,0	55,0	55,0	17,43	4,84	6,45	3,05	36,5	29,0	
116,0	55,0	55,0	17,98	5,45	6,57	3,19	37,1	29,3	
140,0	66,0	66,0	41,20	11,29	11,02	5,09	43,3	34,6	
140,0	66,0	66,0	42,52	12,48	11,20	5,28	44,1	34,9	
136,0	66,0	66,0	44,11	14,58	11,41	5,59	45,2	33,7	
168,0	80,0	80,0	122,67	37,57	19,89	9,95	56,2	42,0	
168,0	80,0	80,0	127,14	42,83	20,22	10,46	57,1	42,4	
208,0	100,0	100,0	371,12	206,06	37,26	25,41	71,3	54,3	



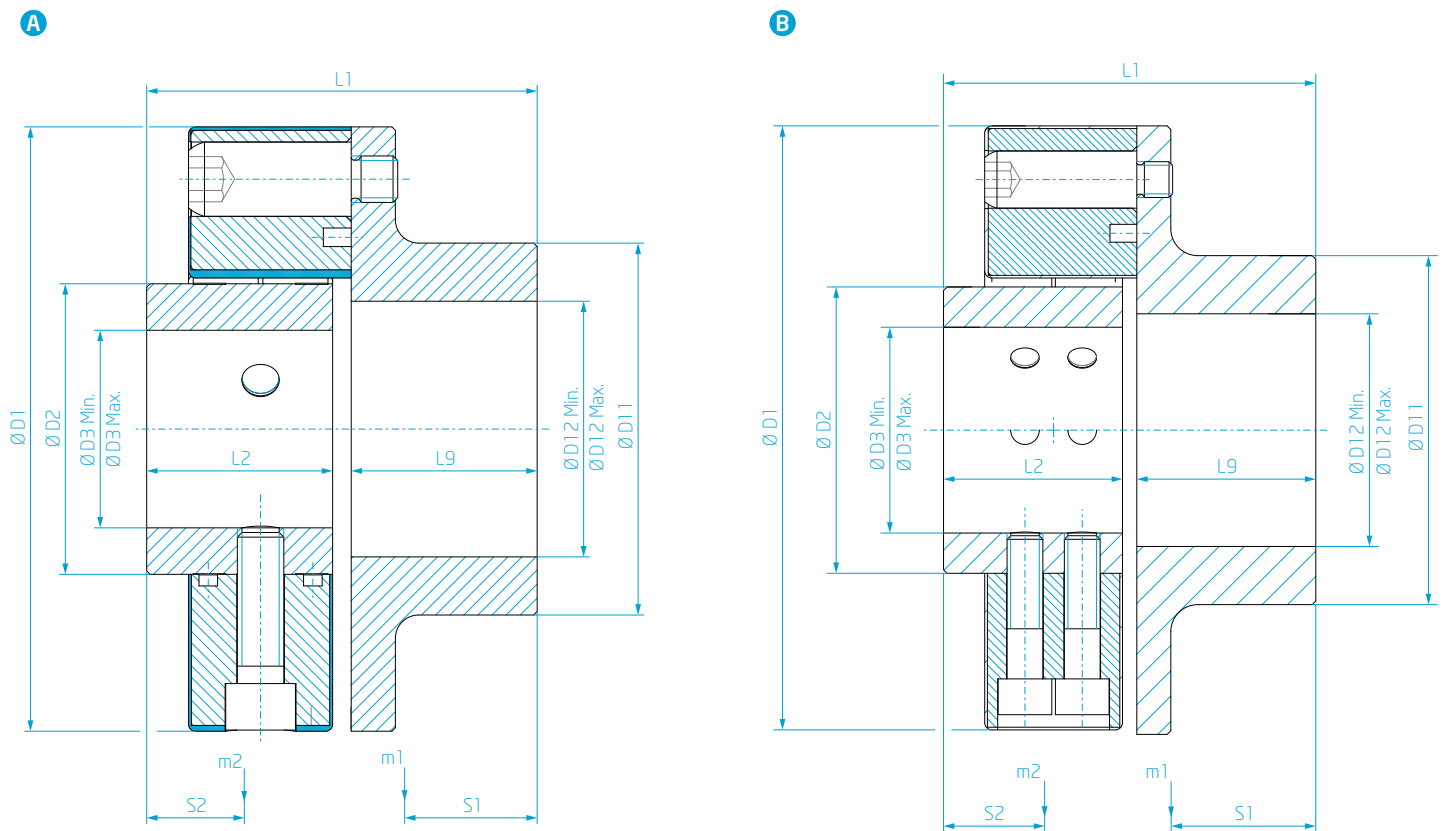

### GEOMETRISCHE DATEN GEOMETRIC DATA

Baugruppe Dimension Group	Abbildung Figure	Abmessungen Dimension							
		D <sub>1</sub> [mm]	D <sub>2</sub> [mm]	D <sub>3</sub> [mm]		D <sub>11</sub> [mm]	D <sub>12</sub> [mm]		
				Min.	Max.		Min.	Max.	
J 0420	A	56,0	30,0	8,0	19,0	36,0	8,0	25,0	
J 0620	A	85,0	40,0	10,0	26,0	55,0	12,0	38,0	
J 0830	A	100,0	45,0	12,0	30,0	65,0	15,0	45,0	
J 1030	A	122,0	60,0	12,0	38,0	80,0	18,0	55,0	
J 1040	A	122,0	60,0	12,0	38,0	80,0	18,0	55,0	
J 1230	A	150,0	70,0	15,0	48,0	100,0	20,0	70,0	
J 1240	A	150,0	70,0	15,0	48,0	100,0	20,0	70,0	
J 1430	A	170,0	85,0	15,0	55,0	115,0	20,0	85,0	
J 1440	A	170,0	85,0	15,0	55,0	115,0	20,0	85,0	
J 1630	A	200,0	100,0	20,0	65,0	140,0	25,0	100,0	
J 1640	A	200,0	100,0	20,0	65,0	140,0	25,0	100,0	
J 1740	A	205,0	100,0	20,0	65,0	140,0	25,0	100,0	
J 2130	A	260,0	125,0	30,0	85,0	160,0	30,0	110,0	
J 2140	A	260,0	125,0	30,0	85,0	160,0	30,0	110,0	
J 2840	B	340,0	160,0	40,0	115,0	195,0	40,0	130,0	

Abmessungen Dimension			Massenträgheitsmomente Mass moments of inertia		Masse Mass		Schwerpunktsabstand Distance to center of gravity		Anmerkungen Notes
$L_1$	$L_2$	$L_g$	$J_1$	$J_2$	$m_1$	$m_2$	$S_1$	$S_2$	
[mm]	[mm]	[mm]	[kgm <sup>2</sup> 10 <sup>-3</sup> ]	[kgm <sup>2</sup> 10 <sup>-3</sup> ]	[kg]	[kg]	[mm]	[mm]	
50,0	24,0	24,0	0,09	0,04	0,31	0,18	17,1	12,3	
60,0	28,0	28,0	0,59	0,30	0,85	0,51	20,1	15,8	
64,0	30,0	30,0	1,17	0,29	1,23	0,51	21,3	15,8	
88,0	42,0	42,0	3,30	0,94	2,44	1,16	28,5	22,4	
88,0	42,0	42,0	3,45	1,04	2,50	1,21	29,1	22,6	
106,0	50,0	50,0	9,52	2,41	5,52	1,97	34,0	26,6	
106,0	50,0	50,0	9,93	2,74	4,63	2,07	34,8	26,9	
116,0	55,0	55,0	18,10	4,85	6,58	3,10	37,2	29,0	
116,0	55,0	55,0	18,84	5,45	6,74	3,19	38,1	29,3	
140,0	66,0	66,0	42,75	11,28	11,24	5,09	44,3	34,6	
140,0	66,0	66,0	44,57	12,48	15,00	5,28	45,3	34,9	
136,0	66,0	66,0	46,14	14,58	11,70	5,59	46,4	33,7	
168,0	80,0	80,0	127,48	37,57	20,30	9,95	57,2	42,0	
168,0	80,0	80,0	133,55	42,83	20,77	10,46	58,4	42,4	
208,0	100,0	100,0	385,03	206,06	37,97	25,41	72,5	54,3	

Alle Massen, Schwerpunkte und Massenträgheitsmomente beziehen sich auf min. Nabendurchmesser.

All masses, focal points and mass moments of inertia refer to min. hub diameter.



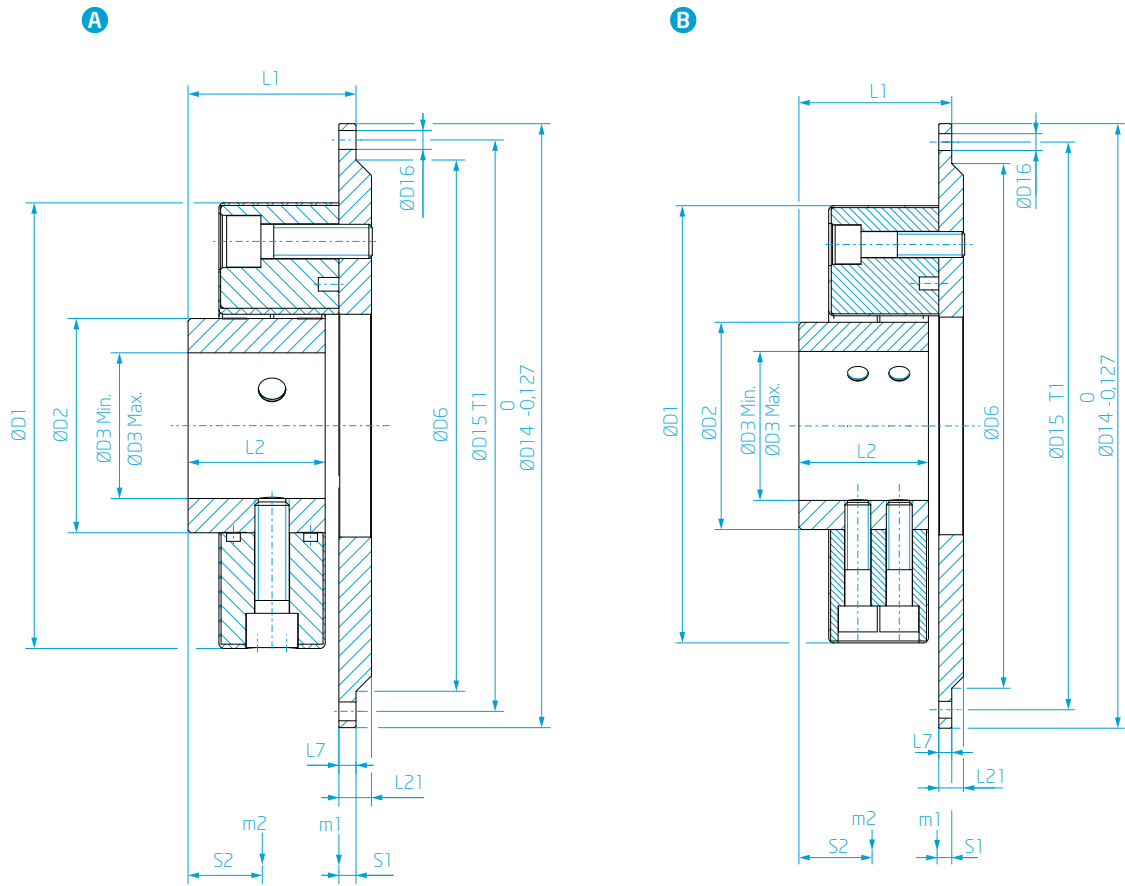

### GEOMETRISCHE DATEN GEOMETRIC DATA

Baugruppe Dimension Group	Schwungrad Flywheel	Abbildung Figure	Abmessungen Dimension									
			$D_1$ [mm]	$D_2$ [mm]	$D_3$ [mm] Min.	$D_3$ [mm] Max.	$D_6$ [mm]	$D_{14}$ [mm]	$D_{15}$ [mm]	$T_1$ [-] Teilung/holes	$D_{16}$ [mm]	
	<b>SAEJ620</b>											
	[°]											
J 1030	6½	A	122,0	60,0	12,0	38,0	180,0	215,9	200,0	6	9,0	
J 1030	7½	A	122,0	60,0	12,0	38,0	200,0	241,3	222,3	8	9,0	
J 1230	6½	A	150,0	70,0	15,0	48,0	180,0	215,9	200,0	6	9,0	
J 1230	7½	A	150,0	70,0	15,0	48,0	200,0	241,3	222,3	8	9,0	
J 1230	8	A	150,0	70,0	15,0	48,0	220,0	263,5	244,5	6	11,0	
J 1430	8	A	170,0	85,0	15,0	55,0	220,0	263,5	244,5	6	11,0	
J 1430	10	A	170,0	85,0	15,0	55,0	270,0	314,3	295,3	8	11,0	
J 1630	10	A	200,0	100,0	20,0	65,0	270,0	314,3	295,3	8	11,0	
J 1630	11½	A	200,0	100,0	20,0	65,0	310,0	352,4	333,4	8	11,0	
J 1640	10	A	200,0	100,0	20,0	65,0	270,0	314,3	295,3	8	11,0	
J 1640	11½	A	200,0	100,0	20,0	65,0	310,0	352,4	333,4	8	11,0	
J 2130	11½	A	260,0	125,0	30,0	85,0	310,0	352,4	333,4	8	11,0	
J 2130	14	A	260,0	125,0	30,0	85,0	405,0	466,7	438,2	8	13,0	
J 2140	11½	A	260,0	125,0	30,0	85,0	310,0	352,4	333,4	8	11,0	
J 2140	14	A	260,0	125,0	30,0	85,0	405,0	466,7	438,2	8	13,0	
J 2840	11½	B	340,0	160,0	40,0	115,0	310,0	352,4	333,4	8	11,0	
J 2840	14	B	340,0	160,0	40,0	115,0	405,0	466,7	438,2	8	13,0	

Abmessungen Dimension				Massenträgheitsmomente Mass moments of inertia		Masse Mass		Schwerpunktsabstand Distance to center of gravity		Anmerkungen Notes
$L_1$	$L_2$	$L_7$	$L_{21}$	$J_1$	$J_2$	$m_1$	$m_2$	$S_1$	$S_2$	
[mm]	[mm]	[mm]	[mm]	[kgm <sup>2</sup> 10 <sup>-3</sup> ]	[kgm <sup>2</sup> 10 <sup>-3</sup> ]	[kg]	[kg]	[mm]	[mm]	
52,0	42,0	6,0	10,0	13,21	0,94	2,46	1,16	3,5	22,4	
52,0	42,0	6,0	10,0	20,30	0,94	3,07	1,16	3,1	22,4	
62,0	50,0	6,0	12,0	15,24	2,41	2,80	1,97	4,5	26,6	
62,0	50,0	6,0	12,0	22,90	2,41	3,49	1,97	3,7	26,6	
62,0	50,0	6,0	12,0	32,66	2,41	4,21	1,97	3,2	26,6	
67,0	55,0	6,0	14,0	36,38	4,85	4,65	3,05	3,5	29,0	
71,0	55,0	10,0	14,0	91,02	4,85	7,61	3,05	5,7	29,0	
84,0	66,0	10,0	16,0	101,18	11,30	8,50	5,09	7,0	34,6	
84,0	66,0	10,0	16,0	161,42	11,30	10,90	5,09	5,9	34,6	
84,0	66,0	10,0	16,0	102,51	12,48	8,68	5,28	7,6	34,9	
84,0	66,0	10,0	16,0	162,75	12,48	11,09	5,28	6,4	34,9	
98,0	80,0	10,0	19,0	194,20	37,57	12,90	9,95	9,0	42,0	
98,0	80,0	10,0	19,0	551,82	37,57	22,32	9,95	5,8	42,0	
98,0	80,0	10,0	19,0	198,67	42,83	13,23	10,46	9,8	42,4	
98,0	80,0	10,0	19,0	565,64	42,83	23,45	10,46	7,4	42,4	
118,0	100,0	10,0	19,0	313,89	206,06	16,62	25,41	24,9	54,3	
118,0	100,0	10,0	19,0	592,64	206,06	22,86	25,41	11,5	54,3	

Alle Massen, Schwerpunkte und Massenträgheitsmomente beziehen sich auf min. Nabendurchmesser.

All masses, focal points and mass moments of inertia refer to min. hub diameter.



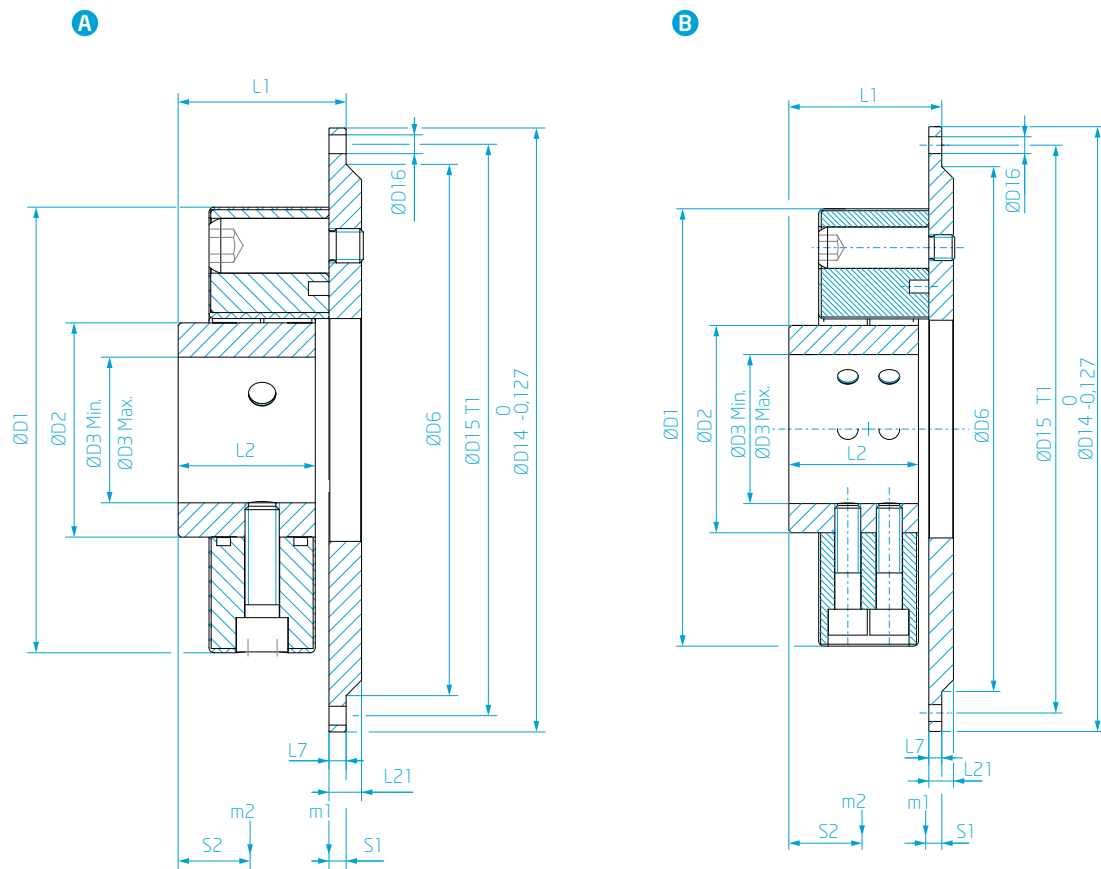

### GEOMETRISCHE DATEN GEOMETRIC DATA

Baugruppe Dimension Group	Schwungrad Flywheel	Abbildung Figure	Abmessungen Dimension									
			$D_1$ [mm]	$D_2$ [mm]	$D_3$ [mm] Min.	$D_3$ [mm] Max.	$D_6$ [mm]	$D_{14}$ [mm]	$D_{15}$ [mm]	$T_1$ [-] Teilung/holes	$D_{16}$ [mm]	
	<b>SAEJ620</b>											
	[°]											
J 1030	6½	A	122,0	60,0	12,0	38,0	180,0	215,9	200,0	6	9,0	
J 1030	7½	A	122,0	60,0	12,0	38,0	200,0	241,3	222,3	8	9,0	
J 1230	6½	A	150,0	70,0	15,0	48,0	180,0	215,9	200,0	6	9,0	
J 1230	7½	A	150,0	70,0	15,0	48,0	200,0	241,3	222,3	8	9,0	
J 1230	8	A	150,0	70,0	15,0	48,0	220,0	263,5	244,5	6	11,0	
J 1430	8	A	170,0	85,0	15,0	55,0	220,0	263,5	244,5	6	11,0	
J 1430	10	A	170,0	85,0	15,0	55,0	270,0	314,3	295,3	8	11,0	
J 1630	10	A	200,0	100,0	20,0	65,0	270,0	314,3	295,3	8	11,0	
J 1630	11½	A	200,0	100,0	20,0	65,0	310,0	352,4	333,4	8	11,0	
J 1640	10	A	200,0	100,0	20,0	65,0	270,0	314,3	295,3	8	11,0	
J 1640	11½	A	200,0	100,0	20,0	65,0	310,0	352,4	333,4	8	11,0	
J 2130	11½	A	260,0	125,0	30,0	85,0	310,0	352,4	333,4	8	11,0	
J 2130	14	A	260,0	125,0	30,0	85,0	405,0	466,7	438,2	8	13,0	
J 2140	11½	A	260,0	125,0	30,0	85,0	310,0	352,4	333,4	8	11,0	
J 2140	14	A	260,0	125,0	30,0	85,0	405,0	466,7	438,2	8	13,0	
J 2840	11½	B	340,0	160,0	40,0	115,0	310,0	352,4	333,4	8	11,0	
J 2840	14	B	340,0	160,0	40,0	115,0	405,0	466,7	438,2	8	13,0	



Abmessungen Dimension				Massenträgheitsmomente Mass moments of inertia		Masse Mass		Schwerpunktsabstand Distance to center of gravity		Anmerkungen Notes
$L_1$	$L_2$	$L_7$	$L_{21}$	$J_1$	$J_2$	$m_1$	$m_2$	$S_1$	$S_2$	
[mm]	[mm]	[mm]	[mm]	[kgm <sup>2</sup> 10 <sup>-3</sup> ]	[kgm <sup>2</sup> 10 <sup>-3</sup> ]	[kg]	[kg]	[mm]	[mm]	
52,0	42,0	6,0	10,0	13,34	0,94	2,51	1,16	3,8	22,4	
52,0	42,0	6,0	10,0	20,43	0,94	3,12	1,16	3,3	22,4	
62,0	50,0	6,0	12,0	15,63	2,41	2,90	1,97	5,3	26,6	
62,0	50,0	6,0	12,0	23,29	2,41	3,59	1,97	4,4	26,6	
62,0	50,0	6,0	12,0	33,05	2,41	4,31	1,97	3,7	26,6	
67,0	55,0	6,0	14,0	37,03	4,85	4,78	3,05	4,2	29,0	
71,0	55,0	10,0	14,0	91,85	4,85	7,80	3,05	6,1	29,0	
84,0	66,0	10,0	16,0	102,71	11,30	8,72	5,09	7,6	34,6	
84,0	66,0	10,0	16,0	162,96	11,30	11,12	5,09	6,6	34,6	
84,0	66,0	10,0	16,0	104,55	12,48	8,98	5,28	8,6	34,9	
84,0	66,0	10,0	16,0	164,80	12,48	11,38	5,28	7,2	34,9	
98,0	80,0	10,0	19,0	199,01	37,57	13,31	9,95	10,0	42,0	
98,0	80,0	10,0	19,0	556,63	37,57	22,73	9,95	6,4	42,0	
98,0	80,0	10,0	19,0	205,08	42,83	13,78	10,46	11,0	42,4	
98,0	80,0	10,0	19,0	562,69	42,83	23,20	10,46	7,1	42,4	
129,0	100,0	10,0	21,0	327,81	206,06	17,32	25,41	26,3	54,3	
118,0	100,0	10,0	19,0	606,55	206,06	23,56	25,41	12,6	54,3	

Alle Massen, Schwerpunkte und Massenträgheitsmomente beziehen sich auf min. Nabendurchmesser.

All masses, focal points and mass moments of inertia refer to min. hub diameter.



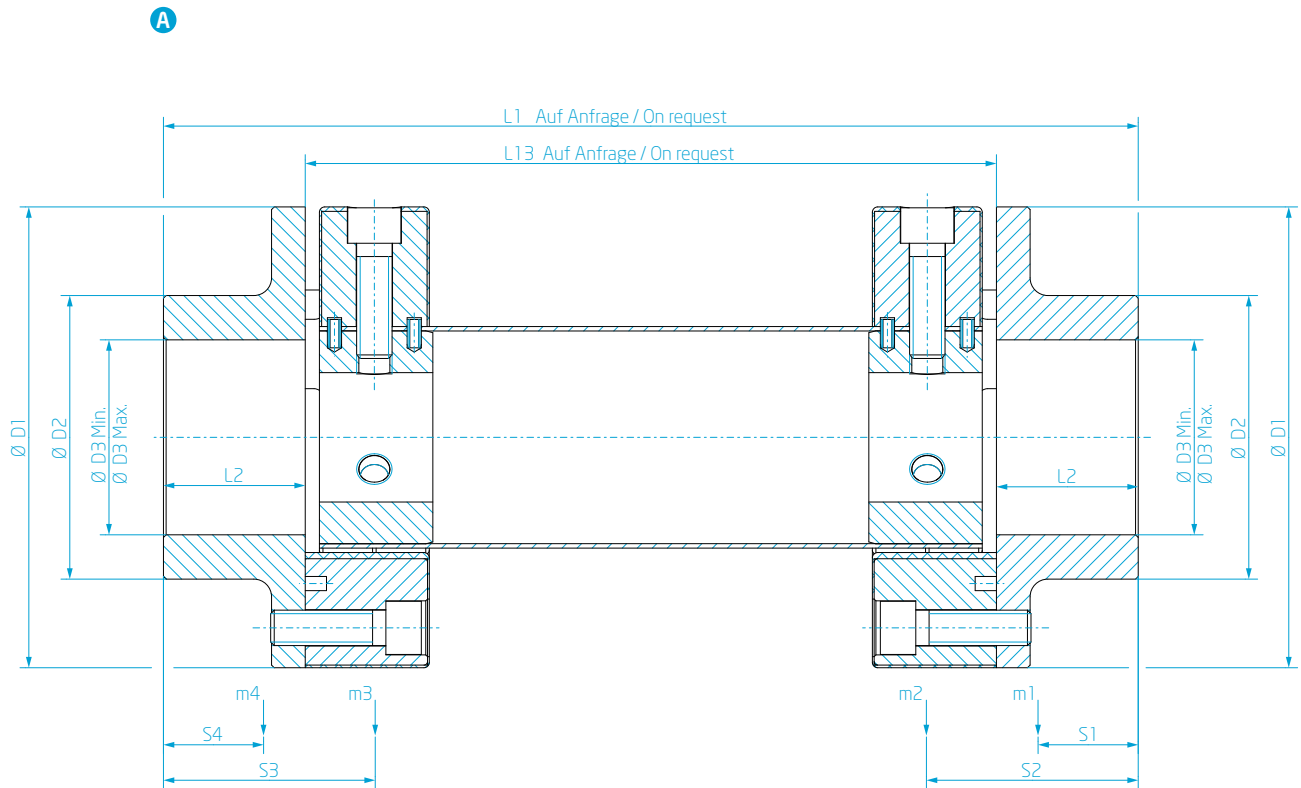

### GEOMETRISCHE DATEN GEOMETRIC DATA

Baugruppe Dimension Group	Abbildung Figure	Abmessungen Dimension					Massenträgheitsmomente Mass moments of inertia			
		D <sub>1</sub> [mm]	D <sub>2</sub> [mm]	D <sub>3</sub> [mm] Min. Max.		L <sub>2</sub> [mm]	J <sub>1</sub> [kgm <sup>2</sup> 10 <sup>-3</sup> ]	J <sub>2</sub> [kgm <sup>2</sup> 10 <sup>-3</sup> ]	J <sub>3</sub> [kgm <sup>2</sup> 10 <sup>-3</sup> ]	J <sub>4</sub> [kgm <sup>2</sup> 10 <sup>-3</sup> ]
J0420	A	56,0	36,0	8,0	25,0	24,0	0,10	-	-	0,10
J0620	A	85,0	55,0	12,0	38,0	28,0	0,59	-	-	0,59
J0830	A	100,0	65,0	15,0	45,0	30,0	1,11	-	-	1,11
J1030	A	122,0	80,0	18,0	55,0	42,0	3,20	0,73	0,73	3,20
J1040	A	122,0	80,0	18,0	55,0	42,0	3,30	0,83	0,83	3,30
J1230	A	150,0	100,0	20,0	70,0	50,0	9,10	2,00	2,00	9,10
J1240	A	150,0	100,0	20,0	70,0	50,0	9,41	2,33	2,33	9,41
J1430	A	170,0	115,0	20,0	85,0	55,0	17,38	3,79	3,79	17,38
J1440	A	170,0	115,0	20,0	85,0	55,0	17,95	4,38	4,38	17,95
J1630	A	200,0	140,0	25,0	100,0	66,0	41,10	9,10	9,10	41,10
J1640	A	200,0	140,0	25,0	100,0	66,0	42,30	10,40	10,40	42,30
J1740	A	205,0	140,0	25,0	100,0	66,0	44,00	12,90	12,90	44,00
J2130	A	260,0	160,0	30,0	110,0	80,0	122,00	31,60	31,60	122,00
J2140	A	260,0	160,0	30,0	110,0	80,0	126,60	36,90	36,90	126,60
J2840	B	340,0	195,0	40,0	130,0	100,0	371,00	187,40	187,40	371,00

**B**

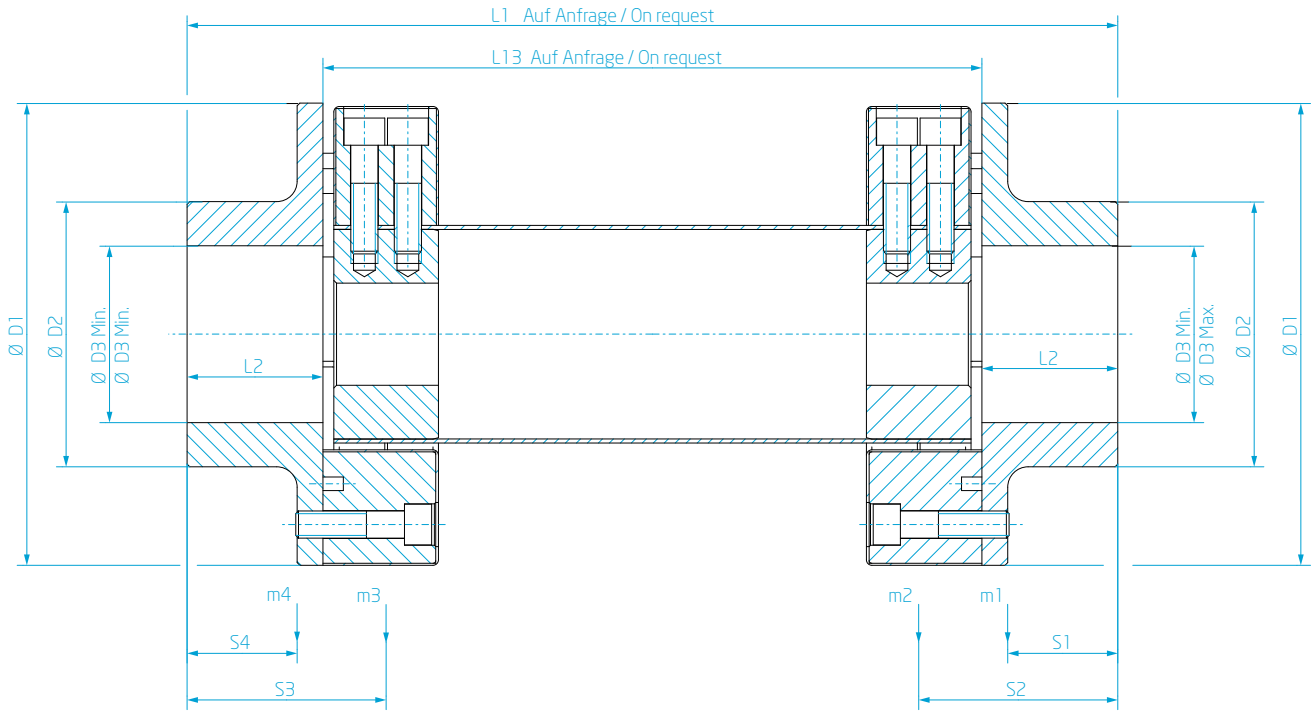

Masse Mass	Schwerpunktsabstand Distance to center of gravity				Anmerkungen Notes			
	$m_1$ [kg]	$m_2$ [kg]	$m_3$ [kg]	$m_4$ [kg]	$S_1$ [mm]	$S_2$ [mm]	$S_3$ [mm]	$S_4$ [mm]
0,30	-	-	-	0,30	16,7	-	-	16,7
0,84	-	-	-	0,84	19,9	-	-	19,9
1,19	-	-	-	1,19	20,7	-	-	20,7
2,30	0,60	0,60	2,30	28,2	60,6	60,6	28,2	
2,30	0,64	0,64	2,30	28,7	60,5	60,5	28,7	
4,30	1,20	1,20	4,30	33,5	74,9	74,9	33,5	
4,37	1,25	1,25	4,37	34,1	74,8	74,8	34,1	
6,29	1,59	1,59	6,29	36,7	81,6	81,6	36,7	
6,40	1,73	1,73	6,40	37,4	81,5	81,5	37,4	
10,70	2,90	2,90	10,70	43,6	99,3	99,3	43,6	
10,90	3,10	3,10	10,90	44,3	99,3	99,3	44,3	
11,10	3,70	3,70	11,10	45,6	100,5	100,5	45,6	
19,40	5,90	5,90	19,40	56,5	119,6	119,6	56,5	
19,70	6,40	6,40	19,70	57,4	120,0	120,0	57,4	
36,20	18,30	18,30	36,20	71,9	146,0	146,0	71,9	

Alle Massen, Schwerpunkte und Massenträgheitsmomente beziehen sich auf min. Nabdurchmesser ohne Welle. Die Wellenlänge kann im Anwendungsfall variabel ausgelegt werden. Siehe Seite 30.

All masses and mass moments of inertia refer to pilot bored hubs without a shaft. The shaft length can be chosen individually. Please refer to page 30ff.



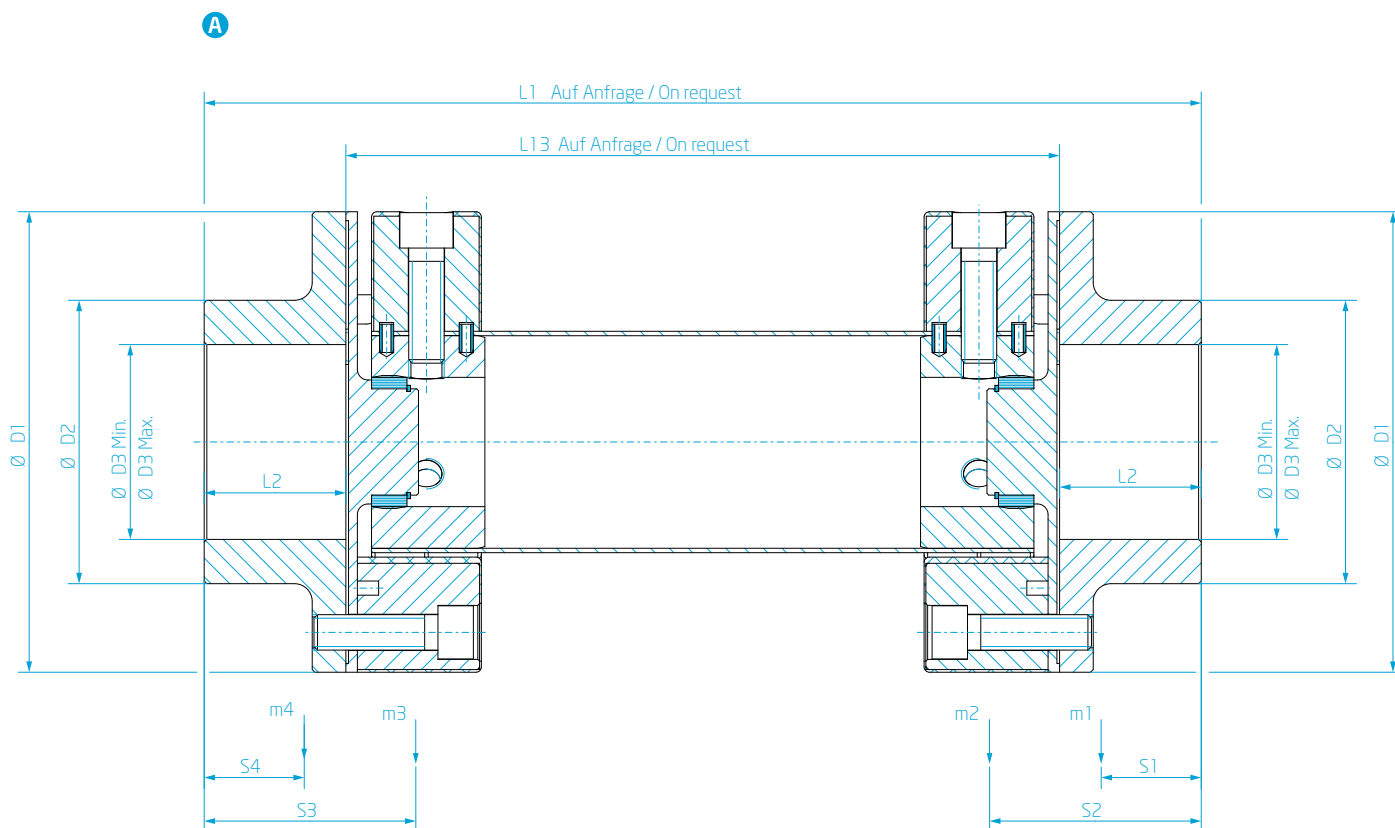

### GEOMETRISCHE DATEN GEOMETRIC DATA

Baugruppe Dimension Group	Abbildung Figure	Abmessungen Dimension					Massenträgheitsmomente Mass moments of inertia			
		D <sub>1</sub> [mm]	D <sub>2</sub> [mm]	D <sub>3</sub> [mm] Min. Max.		L <sub>2</sub> [mm]	J <sub>1</sub> [kgm <sup>2</sup> 10 <sup>-3</sup> ]	J <sub>2</sub> [kgm <sup>2</sup> 10 <sup>-3</sup> ]	J <sub>3</sub> [kgm <sup>2</sup> 10 <sup>-3</sup> ]	J <sub>4</sub> [kgm <sup>2</sup> 10 <sup>-3</sup> ]
J0420	A	56,0	36,0	8,0	25,0	24,0	-	-	-	-
J0620	A	85,0	55,0	12,0	38,0	28,0	-	-	-	-
J0830	A	100,0	65,0	15,0	45,0	30,0	-	-	-	-
J1030	A	122,0	80,0	18,0	55,0	42,0	3,90	0,72	0,72	3,90
J1040	A	122,0	80,0	18,0	55,0	42,0	4,10	0,82	0,82	4,10
J1230	A	150,0	100,0	20,0	70,0	50,0	11,00	2,00	2,00	11,00
J1240	A	150,0	100,0	20,0	70,0	50,0	11,31	2,32	2,32	11,31
J1430	A	170,0	115,0	20,0	85,0	55,0	20,61	3,75	3,75	20,61
J1440	A	170,0	115,0	20,0	85,0	55,0	21,19	4,34	4,34	21,19
J1630	A	200,0	140,0	25,0	100,0	66,0	47,30	9,00	9,00	47,30
J1640	A	200,0	140,0	25,0	100,0	66,0	48,70	10,30	10,30	48,70
J1740	A	205,0	140,0	25,0	100,0	66,0	50,30	12,90	12,90	50,30
J2130	A	260,0	160,0	30,0	110,0	80,0	140,00	31,30	31,30	140,00
J2140	A	260,0	160,0	30,0	110,0	80,0	144,00	36,60	36,60	144,00
J2840	B	340,0	195,0	40,0	130,0	100,0	473,00	187,00	187,00	473,00

**B**

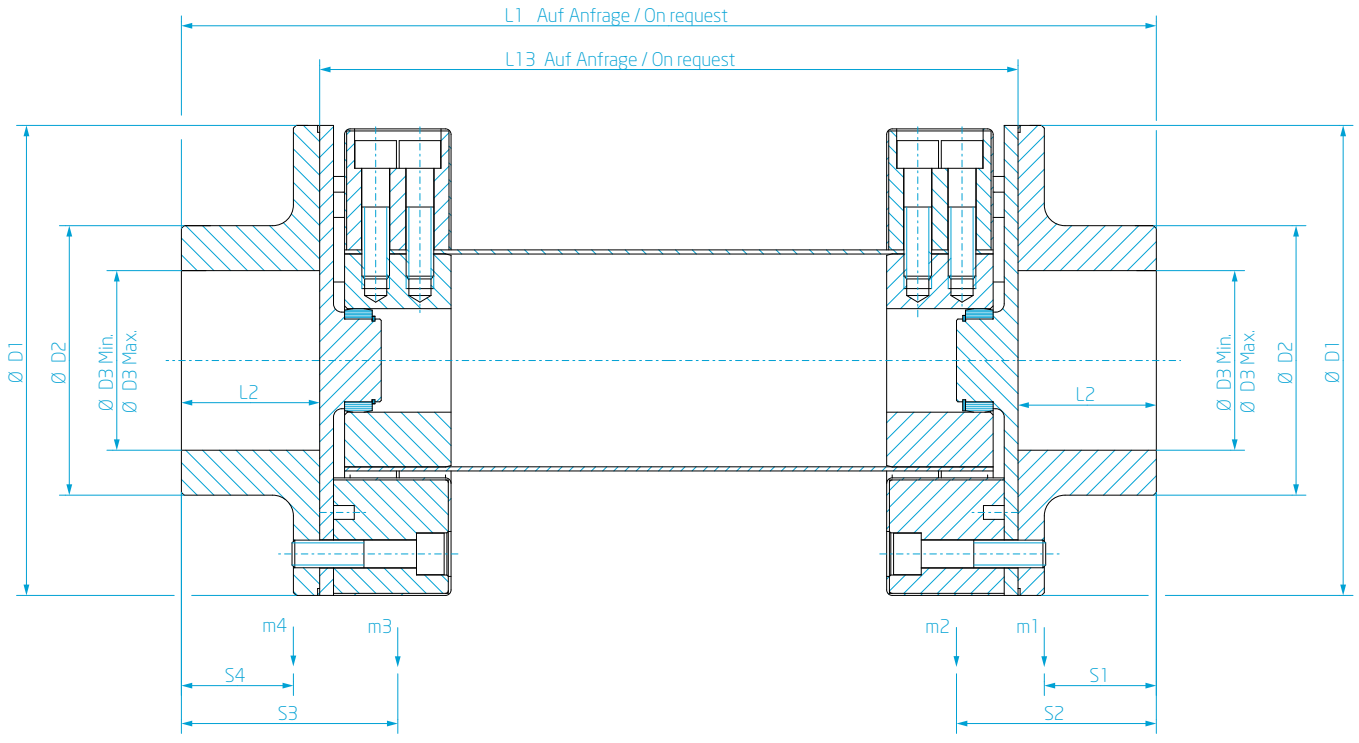

Masse Mass	Schwerpunktsabstand Distance to center of gravity				Anmerkungen Notes			
	m <sub>1</sub> [kg]	m <sub>2</sub> [kg]	m <sub>3</sub> [kg]	m <sub>4</sub> [kg]	S <sub>1</sub> [mm]	S <sub>2</sub> [mm]	S <sub>3</sub> [mm]	S <sub>4</sub> [mm]
-	-	-	-	-	-	-	-	-
-	-	-	-	-	-	-	-	-
-	-	-	-	-	-	-	-	-
2,80	0,57	0,57	2,80	32,2	65,5	65,5	32,2	
2,90	0,62	0,62	2,90	32,6	65,5	65,5	32,6	
5,20	1,10	1,10	5,20	37,6	79,8	79,8	37,6	
5,23	1,22	1,22	5,23	38,1	79,8	79,8	38,1	
7,50	1,54	1,54	7,50	41,1	86,5	86,5	41,1	
7,62	1,69	1,69	7,62	41,7	86,5	86,5	41,7	
12,40	2,80	2,80	12,40	48,2	104,2	104,2	48,2	
12,60	3,00	3,00	12,60	49,0	104,2	104,2	49,0	
12,80	3,70	3,70	12,80	50,0	105,4	105,4	50,0	
22,30	5,70	5,70	22,30	61,1	124,5	124,5	61,1	
22,60	6,20	6,20	22,60	62,0	125,0	125,0	62,0	
44,20	18,20	18,20	44,20	79,3	156,0	156,0	79,3	

All masses, centers of gravity and mass moments of inertia refer to pilot bored hubs without a shaft. The shaft length can be chosen individually. Please refer to page 30ff.



### AUSLEGUNG DER BAUREIHE 1740

Die Gelenkwelleausführung gemäß Baureihe 1740 ist geeignet für kleine und mittlere Baulängen bei einer maximalen Drehzahl von  $n = 1.800 \text{ min}^{-1}$ . Die maximal zulässige Länge des Mittelteils ist abhängig von der Drehzahl und der Baugröße der Kupplung. Eine entsprechende Kupplungsauswahl nehmen Sie bitte anhand des Diagramms (Seite 31) vor.

Hinsichtlich der technischen Daten ergeben sich für die hier vorliegende Reihenschaltung zweier MEGIFLEX B-Elemente folgende Veränderungen:

- ⌚ der Wert  $C_{\text{Tdyn}}$  wird halbiert
- ⌚ die axiale Steifigkeit  $C_{\text{axial}}$  wird halbiert

### AUSLEGUNG DER BAUREIHE 1750, GELENKWELLENAUSFÜHRUNG MIT INNENLAGERUNG

Oberhalb einer Drehzahl von  $n = 1.800 \text{ min}^{-1}$  muß die MEGIFLEX B-Gelenkwelle innen gelagert werden.

Für eine sichere Auslegung im konkreten Einsatzfall bitten wir um Rücksprache mit ihrer lokalen VULKAN Vertretung.

### SELECTION OF SERIES 1740

The cardan shaft design according to series 1740 is suitable for small and medium overall lengths at a max. speed of  $n = 1,800 \text{ rpm}$ . The max. permissible length of the centre section piece depends on the speed and the size of the coupling, a corresponding coupling selection can be made, using the mentioned diagram (Page 31).

Regarding the technical data, following changes result from the present series connection of two MEGIFLEX B elements:

- ⌚ the value  $C_{\text{Tdyn}}$  will be halved
- ⌚ the axial stiffness  $C_{\text{axial}}$  will be halved

### SELECTION OF SERIES 1750, CARDAN SHAFT DESIGN WITH INTERNAL BEARING

At speeds above  $n = 1,800 \text{ rpm}$  the MEGIFLEX B cardan shaft has to be internally supported.

For a safe selection in a defined installation please contact VULKAN.

# 1740

Drehzahl Rotational Speed  $n$  [1/min]

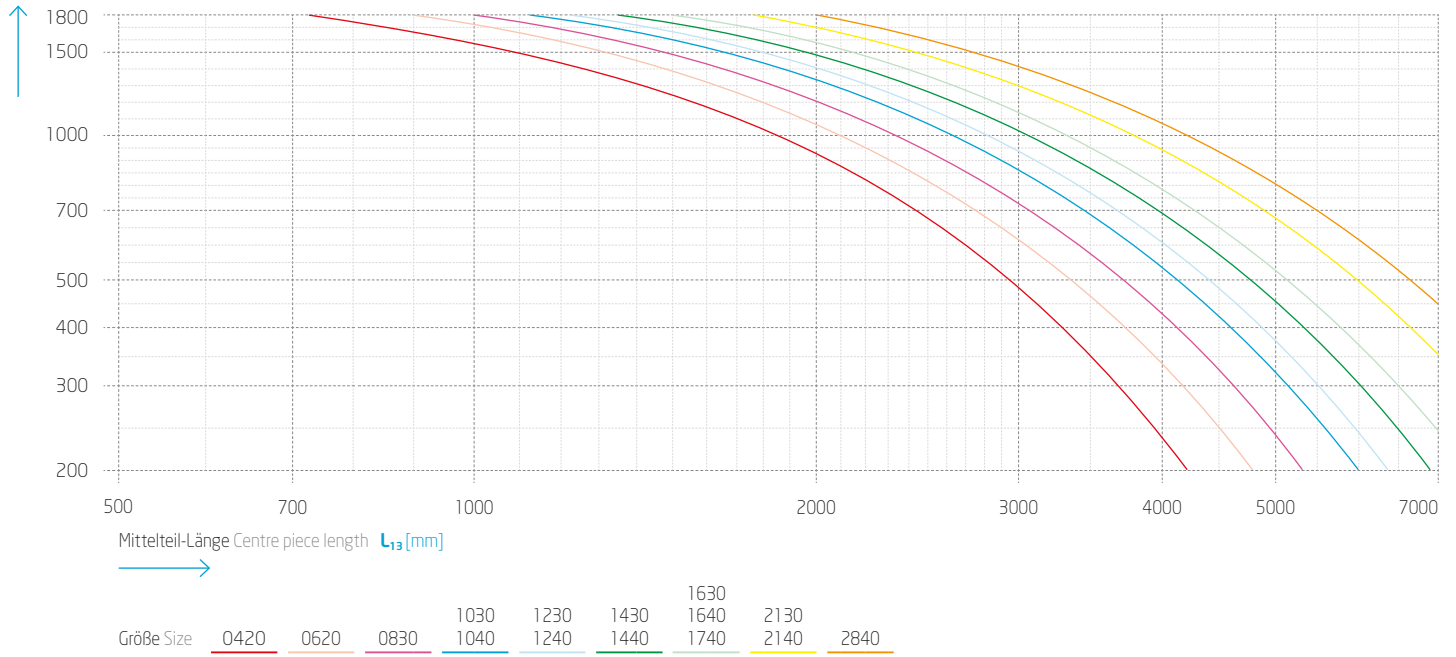

# MEGIFLEX B

## ERLÄUTERUNGEN DES PRODUKT-CODES EXPLANATIONS OF THE PRODUCT CODE

Alle VULKAN Couplings Produkte sind mit einem Produktcode gekennzeichnet. Dieser Code setzt sich aus verschiedenen Parameter-Angaben zusammen und ermöglicht es, unsere Produkte eindeutig zu identifizieren.

All VULKAN Couplings products are identified by a product code. This code consists of several parameters and it enables the clear identification of all products.

### PRODUKT-CODE BEISPIEL MEGIFLEX B

Hier haben wir den Code am Beispiel einer MEGIFLEX B (**J 1031**), Größe 10, 3 radiale Verschraubungen, Elementsteifigkeit 1, Baureihe 1720, nicht SAE dargestellt.

LEISTUNGSDATEN PERFORMANCE DATA			
Kupplungstyp Type of Coupling		$T_{KN}$	$T_{Kmax1}$
		[Nm]	[Nm]
Größe Size	Baugruppe Dimension Group	Nenn Drehmoment Nominal Torque	Max. Drehmoment Max. Torque
1031	1030	80,00	160,00

Auszug aus den Leistungsdaten. Für vollständige Daten siehe ab Seite 08.  
Excerpt from performance data. Complete data see page 08 ff.

### PRODUCT CODE EXAMPLE MEGIFLEX B

We have decoded here the product code of a MEGIFLEX B (**J 1031**), Size 10, 3 radial bolts, Element stiffness 1, Series 1720, non SAE.

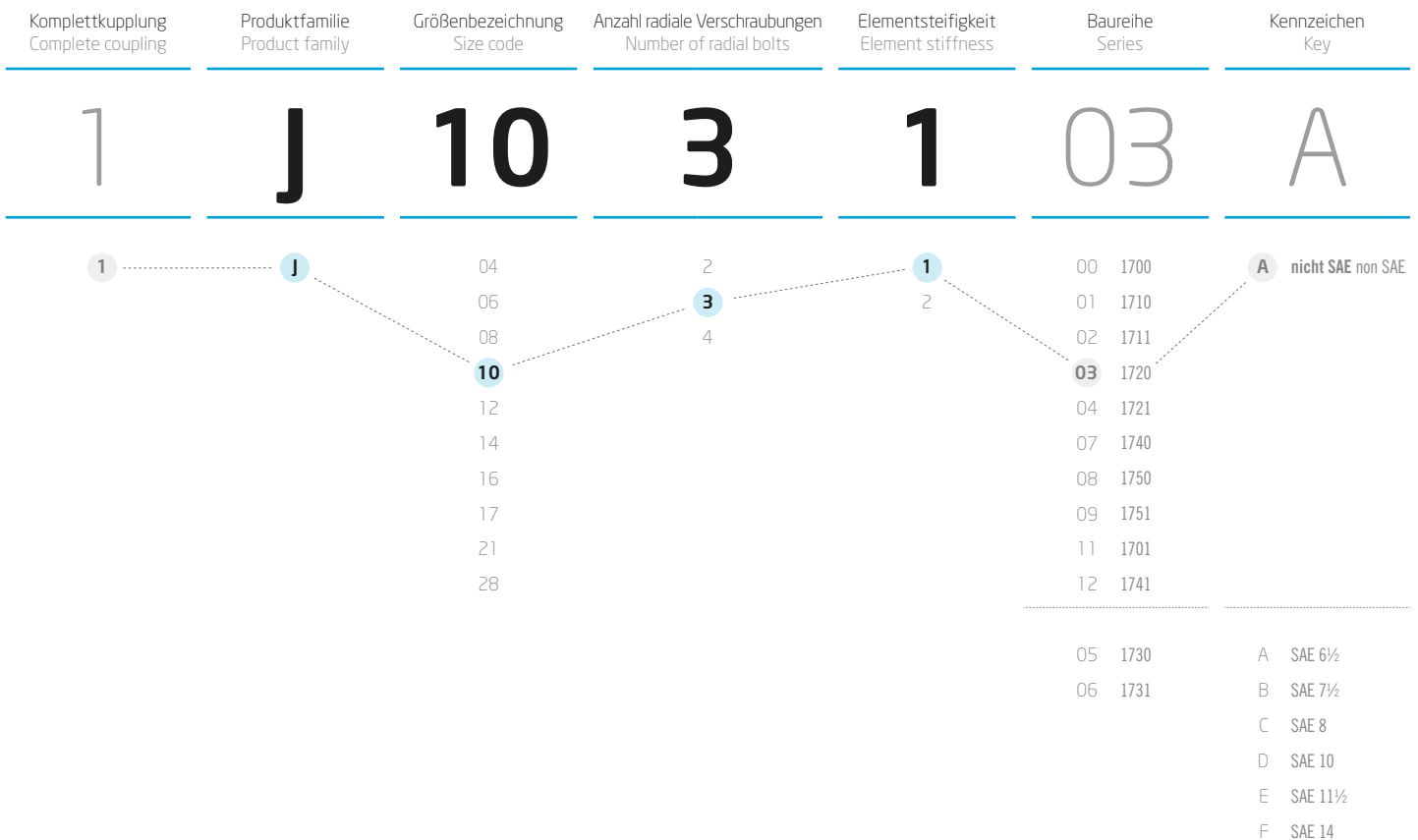



**NOTIZEN** NOTICE

The image shows a technical drawing grid. The grid is composed of small squares, each divided into four triangles by a diagonal line. A central rectangular area is defined by a double-line border and contains four horizontal lines for writing. On the right side, there is a vertical scale from 0 to 220 with tick marks every 10 units.

# ONLINE-SERVICE

WEITERE INFORMATIONEN FINDEN SIE AUF [WWW.VULKAN.COM](http://WWW.VULKAN.COM) FOR FURTHER INFORMATION, PLEASE REFER TO OUR WEBSITE [WWW.VULKAN.COM](http://WWW.VULKAN.COM)

## MEGIFLEX B

[www.vulkan.com/de-de/couplings/produkte/hochelastische-kupplungen/megiflex-b](http://www.vulkan.com/de-de/couplings/produkte/hochelastische-kupplungen/megiflex-b)



## MEGIFLEX B

[www.vulkan.com/en-us/couplings/products/highly-flexible-couplings/megiflex-b](http://www.vulkan.com/en-us/couplings/products/highly-flexible-couplings/megiflex-b)

## KATALOGE & BROSCHÜREN

[www.vulkan.com/de-de/couplings/downloads-videos](http://www.vulkan.com/de-de/couplings/downloads-videos)



## CATALOGUES & BROCHURES

[www.vulkan.com/en-us/couplings/downloads-videos](http://www.vulkan.com/en-us/couplings/downloads-videos)

## VULKAN ENGINEERING PORTAL

[www.vulkan.com/de-de/couplings/service/vulkan-engineering-portal](http://www.vulkan.com/de-de/couplings/service/vulkan-engineering-portal)



## VULKAN ENGINEERING PORTAL

[www.vulkan.com/en-us/couplings/service/vulkan-engineering-portal](http://www.vulkan.com/en-us/couplings/service/vulkan-engineering-portal)

## PRODUKTSELEKTOR

[www.vulkan.com/de-de/couplings/service/produktselektor](http://www.vulkan.com/de-de/couplings/service/produktselektor)



## PRODUCT SELECTOR

[www.vulkan.com/en-us/couplings/service/product-selector](http://www.vulkan.com/en-us/couplings/service/product-selector)

## AUTORISIERTE HÄNDLER

[www.vulkan.com/de-de/couplings/kontakt](http://www.vulkan.com/de-de/couplings/kontakt)



## AUTHORISED DISTRIBUTORS

[www.vulkan.com/en-us/couplings/contact](http://www.vulkan.com/en-us/couplings/contact)

## VIDEOS

[www.vulkan.com/de-de/couplings/downloads-videos/videos](http://www.vulkan.com/de-de/couplings/downloads-videos/videos)



## VIDEOS

[www.vulkan.com/en-us/couplings/downloads-videos/videos](http://www.vulkan.com/en-us/couplings/downloads-videos/videos)

---

## GÜLTIGKEITSKLAUSEL

Die enthaltenen technischen Daten sind nur gültig bei Einsatz in definierten Anwendungsgebieten. Dies umfasst:

- ⌚ Haupt- und Nebenantriebe auf Schiffen
- ⌚ Generatorsätze auf Schiffen
- ⌚ Antriebe für stationäre Energieerzeugung mit Diesel- oder Gasmotoren

Abweichende Anwendungen bedürfen einer individuellen Betrachtung. Bitte kontaktieren Sie hierzu ihren lokalen VULKAN Vertreter.

Die vorliegende Broschüre ersetzt alle vorherigen Ausgaben, ältere Drucke verlieren ihre Gültigkeit. VULKAN ist berechtigt, aufgrund neuerer Entwicklungen die in dieser Broschüre enthaltenen Daten entsprechend anzupassen und zu verändern. Die neuen Daten gelten nur für nach der Änderung bestellte Kupplungen. Es liegt im Verantwortungsbereich des Anwenders dafür zu sorgen, dass ausschließlich die aktuelle Katalogversion verwendet wird. Der jeweils aktuelle Stand ist auf der Webseite von VULKAN unter [www.vulkan.com](http://www.vulkan.com) jederzeit abrufbar.

Die Angaben in dieser Broschüre beziehen sich auf den technischen Standard gültig im Hause VULKAN und stehen unter den in den Erläuterungen definierten Bedingungen. Es liegt allein im Entscheidungs- und Verantwortungsrahmen des Systemverantwortlichen für die Antriebslinie, entsprechende Rückschlüsse auf das Systemverhalten zu ziehen.

VULKAN Drehschwingungsanalysen berücksichtigen in der Regel nur das rein mechanische Schwingungssystem. Als reiner Komponentenhersteller übernimmt VULKAN mit der Analyse des Drehschwingungssystems (stationär, transient) nicht die Systemverantwortung! Die Genauigkeit der Analyse hängt von der Genauigkeit der verwendeten bzw. der VULKAN zur Verfügung gestellten Daten ab.

Änderungen aufgrund des technischen Fortschritts sind vorbehalten. Bei Unklarheiten bzw. Rückfragen kontaktieren Sie bitte VULKAN.

Stand: 07/2018

Das Recht auf Vervielfältigung, Nachdruck und Übersetzungen behalten wir uns vor. Maß- und Konstruktionsänderungen vorbehalten.

## VALIDITY CLAUSE

The containing technical data is valid only for defined areas of applications. This includes:

- ⌚ Main propulsion and auxiliary drives on ships
- ⌚ Generatorsets on ships
- ⌚ Drives for stationary energy production with diesel or gas engines

For other than the named applications please contact your local VULKAN supplier for further consideration.

The present catalogue shall replace all previous editions, any previous printings shall no longer be valid. Based on new developments, VULKAN reserves the right to amend and change any details contained in this catalogue respectively. The new data shall only apply with respect to couplings that were ordered after said amendment or change. It shall be the responsibility of the user to ensure that only the latest catalogue issue will be used. The respective latest issue can be seen on the website of VULKAN on [www.vulkan.com](http://www.vulkan.com).

The data contained in this catalogue refer to the technical standard as presently used by VULKAN with defined conditions according to the explanations. It shall be the sole responsibility and decision of the system administrator for the drive line to draw conclusions about the system behaviour.

VULKAN torsional vibration analysis usually only consider the pure mechanical mass-elastic system. Being a component manufacturer exclusively, VULKAN assumes no system responsibility with the analysis of the torsional vibration system (stationary, transiently)! The accuracy of the analysis depends on the exactness of the used data and the data VULKAN is provided with, respectively.

Any changes due to the technological progress are reserved. For questions or queries please contact VULKAN.

Status: 07/2018

All duplication, reprinting and translation rights are reserved. We reserve the right to modify dimensions and constructions without prior notice.

**PUBLISHER:**

VULKAN Couplings

**CONCEPT AND DESIGN:**

Hackforth Holding GmbH & Co. KG  
VULKAN Marketing  
Heerstraße 66, 44653 Herne / Germany  
E-mail: [marketing@vulkan.com](mailto:marketing@vulkan.com)

**STATUS:** 07/2018

All duplication, reprinting and translation rights are reserved. Any changes due to the technological progress are reserved. For questions or queries please contact VULKAN.